

Electrical - Wiring Accessories (continued)

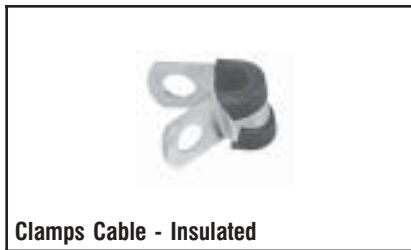

Clamps Cable - Insulated

1/2"	86103 (2)
1/4"	86101 (2)
3/16"	86100 (2)
3/4"	86105 (1)
3/8"	86102 (2)
5/8"	86104 (1)
7/8"	86106 (1)
Assortment 5/16" - 7/16"	85605 (3)



Clamps - Insulated Red & Black

10 Amp	85677 (4)
30 Amp	85678 (2)
50 Amp	85679 (2)

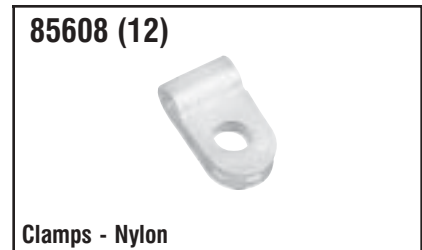

85608 (12)

Clamps - Nylon

Assortment 1/8", 3/16", 1/4"	85608 (12)
------------------------------	-------------------

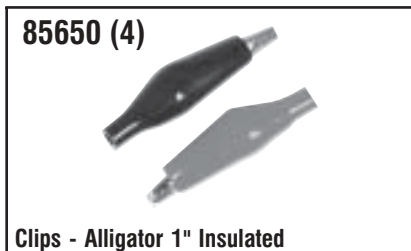

85650 (4)

Clips - Alligator 1" Insulated

85650 (4)



85652 (6)

Clips - Alligator 1-1/2" w/Screw

85652 (6)



85653 (2)

Clips - Alligator Copper w/Screw

85653 (2)

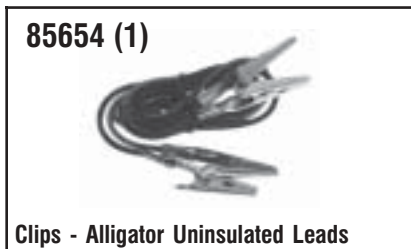

85654 (1)

Clips - Alligator Uninsulated Leads

85654 (1)

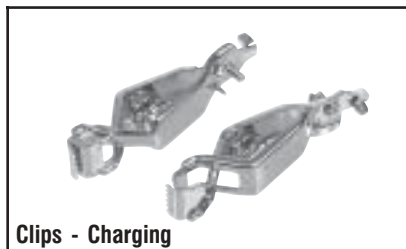

Clips - Charging

10 Amp	85680 (3)
25 Amp	85681 (2)
50 Amp	85682 (1)
Assorted 10 & 25 Amp	85683 (5)



Copper Butt Connectors

1 Ga.	86150 (1)
1/0 Ga.	86151 (1)
2 Ga.	85629 (2)
2/0 Ga.	86152 (1)
3/0 Ga.	86153 (1)
4 Ga.	85630 (2)
4/0 Ga.	86154 (1)
6 Ga.	85631 (2)
8 Ga.	85633 (2)



Electrical - Wiring Accessories (continued)



Copper Ring Lugs

- | | |
|---------------|------------------|
| 1 Ga. 1/2" | 86183 (1) |
| 1 Ga. 1/4" | 86180 (1) |
| 1 Ga. 3/8" | 86182 (1) |
| 1 Ga. 5/16" | 86181 (1) |
| 1/0 Ga. 1/2" | 86187 (1) |
| 1/0 Ga. 3/8" | 86186 (1) |
| 1/0 Ga. 5/16" | 86185 (1) |
| 2 Ga. 1/2" | 86179 (1) |
| 2 Ga. 1/4" | 86176 (1) |
| 2 Ga. 3/8" | 85635 (2) |
| 2 Ga. 5/16" | 86177 (1) |
| 2/0 Ga. 1/2" | 86191 (1) |
| 2/0 Ga. 3/8" | 86190 (1) |
| 2/0 Ga. 5/16" | 86189 (1) |
| 3/0 Ga. 1/2" | 86195 (1) |
| 3/0 Ga. 3/8" | 86194 (1) |
| 3/0 Ga. 5/16" | 86193 (1) |
| 4 Ga. 1/2" | 86175 (2) |
| 4 Ga. 1/4" | 86172 (2) |
| 4 Ga. 3/8" | 85637 (2) |
| 4 Ga. 5/16" | 86173 (2) |
| 4/0 Ga. 1/2" | 86199 (1) |
| 4/0 Ga. 3/8" | 86198 (1) |
| 6 Ga. 1/2" | 86171 (2) |
| 6 Ga. 1/4" | 86168 (2) |
| 6 Ga. 3/8" | 85638 (2) |
| 6 Ga. 5/16" | 86169 (2) |
| 8 Ga. #10 | 86164 (2) |
| 8 Ga. 1/4" | 86165 (2) |
| 8 Ga. 3/8" | 86167 (2) |
| 8 Ga. 5/16" | 85639 (2) |

85668 (1)

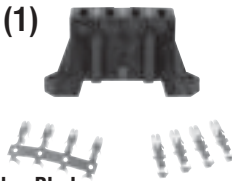

Fuse Block - Blade

Holds 4 Blade Fuses. **85668 (1)**

85666 (1)

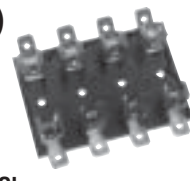

Fuse Block - Glass

Holds 4 Glass Fuses. **85666 (1)**

85646 (1)



Fuse Block GM Battery Connector

Unit plugs into block marked "BAT" for constant live connections.

85646 (1)

85651 (1)

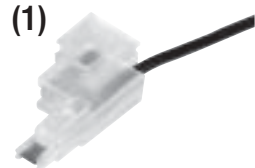

Fuse Block GM Ignition Connector

Unit plugs into block marked "IGN" for connection only when ignition is on.

85651 (1)

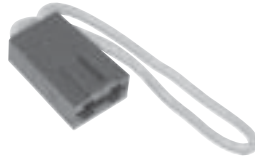

Fuse Holders - Blade Style

- | | |
|------------------------|------------------|
| 12 Ga. - w/o Cap | 85665 (1) |
| 12 Ga. - Waterproof | 84939 (1) |
| 16 Ga. - up to 20 Amps | 84938 (1) |
| Mini Style | 85670 (1) |



Fuse Holders - Glass Style

- | | |
|------------------------|------------------|
| 10 Ga. - w/30 Amp Fuse | 85663 (1) |
| 12 Ga. - w/20 Amp Fuse | 85662 (1) |
| 12 Ga. - w/30 Amp Fuse | 84937 (1) |
| 14 Ga. - w/10 Amp Fuse | 85661 (1) |
| 14 Ga. - w/o Fuse | 84936 (1) |
| 18 Ga. - w/o Fuse | 85660 (1) |

85602 (10)



Fuse Power Taps - Glass

Tap fits underneath metal portion of glass fuse - provides an additional circuit.

85602 (10)

85606 (4)



Fuse Power Taps Kit

Paired with Insulated Disconnects 16-14 .250". Tap slips over blade of fuse - provides an additional circuit for accessories.

85606 (4)

Electrical - Wiring Accessories (continued)

85601 (4)



Fuse Power Taps Mini

Tap slips over blade of fuse - provides an additional circuit for accessories.

85601 (4)

85667 (1)



Fuse Puller

For Glass and Blade Type Fuses. Removes fuses safely. Plastic construction prevents shorts during installation and removal.

85667 (1)



Fusible Link Wire - Carded

Chrysler 14 Ga.	85622 (1)
Chrysler 16 Ga.	85627 (1)
Chrysler 18 Ga.	85628 (1)
Chrysler 20 Ga.	85626 (1)
Ford 14 Ga.	85623 (1)
Ford 16 Ga.	85624 (1)
Ford 18 Ga.	85625 (1)
GM 14 Ga.	85620 (1)
GM 16 Ga.	85621 (1)



Fusible Link Wire Spools 10'

12 Ga.	85766 (1)
14 Ga.	85767 (1)
16 Ga.	85768 (1)
18 Ga.	85769 (1)
20 Ga.	85758 (1)



Fusible Links - Bar Type

Honda 45 Amp	85050 (3)
Honda 55 Amp	85051 (3)
Honda 65 Amp	85052 (3)
Honda Assortment - includes 45 to 65 amps	85619 (3)

Fuse Tap Adapter

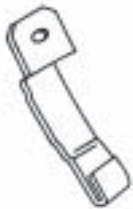

Fig. 1



Fig. 2



Fig. 3



Fig. 4

72204 (1)



Ground Strap

Replaces body to engine block strap. Solves light dimming problems by grounding charging system. Reduces radio noise.

Universal 15" **72204 (1)**



Fusible Links should always be four gauges smaller than the circuit it is protecting (example: use a 14 gauge fusible link to protect a 10 gauge wire circuit).



Grommets

1/2"ID x 5/8"OD	86125 (6)
1/4"ID x 3/8"OD	86122 (8)
1/8"ID x 1/4"OD	86120 (10)
11/16"ID x 1"OD	86128 (2)
25/64"ID x 21/32"OD	86126 (3)
3/16"ID x 5/16"OD	86121 (10)
3/8" ID x 1/2"OD	86124 (6)
5/16"ID x 7/16"OD	86123 (6)
5/8"ID x 7/8"OD	86127 (3)
Assorted 1/2"ID - 11/16"ID	86130 (4)
Assorted 1/4"ID - 7/8"ID	85604 (28)
Assorted 1/8"ID - 3/8"ID	86129 (8)



Electrical - Wiring Accessories (continued)



Heat Shrink Tubing Polyolefin

3" Black Assorted Gauges **85283 (6)**
 6" Black Assorted Widths **85611 (5)**



Heat Shrink Tubing PVC

3" Black 12-10 Ga. **85281 (3)**
 3" Black 16-14 Ga. **85280 (3)**
 3" Black 8-2 Ga. **85282 (3)**
 6" Assorted Colors & Widths **85686 (7)**



Heat Shrink Tubing PVC 96"

Blue 16-14 Ga. **85287 (1)**
 Red 22-18 Ga. **85286 (1)**
 Yellow 12-10 Ga. **85288 (1)**

E

Do you know how to protect your wiring circuit?

Heat Shrink Tubing

- Heat shrink is a protective tubing that shrinks to about half its original diameter when heated to protect soldered connections
- Standard heat shrink tubing is available in opaque colors
- Adhesive lined heat shrink tubing is translucent and seals out moisture – for underhood applications
- OE manufacturers recommend that all wire repairs that may be exposed to moisture be covered with adhesive lined heat shrink tubing

Easy Installation!



Cut tubing to desired length



Slip tubing over wire and connection to be protected



Apply even heat to shrink tubing with Mini Torch (86278). Work from the center of the tubing out. Move back and forth until tubing shrinks and forms a seal.

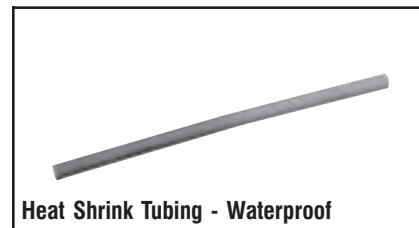

Heat Shrink Tubing - Waterproof

3" Assorted Gauges **85278 (3)**
 6" Assorted Gauges **85275 (1)**

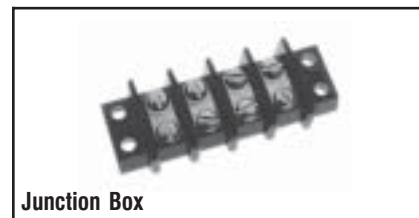

Junction Box

Safely allows for additional wiring circuits to the vehicles electrical system. Use rings, spades or hooks on block.

30 Amp, 4 Post **85685 (1)**



Relays - Universal

12 Volt, 20 Amp General Lighting **84607 (1)**
 4 Pin, 20 Amp, 24 Volt **84604 (1)**
 4 Pin, 30 Amp, 12 Volt **84601 (1)**
 5 Pin, 10/20 Amp, 24 Volt **84603 (1)**
 5 Pin, 20 Amp, 24 Volt **84606 (1)**
 5 Pin, 20/30 Amp, 12 Volt **84602 (1)**
 5 Pin, 30 Amp, 12 Volt **84605 (1)**

Electrical - Wiring Accessories (continued)

85285 (3)



Sealing Compound

Peel-off backing. Quick and easy method of waterproofing electrical connections.

2-1/2" Square **85285 (3)**

85274 (1)



Tape - Cold Shrink

Use for applications too large for shrink tubing. Once tape is stretched over a connection, it becomes a solid form - protecting the connection. Continuous operating temperature of -400° F to 2120° F.

Black 1" x 10' **85274 (1)**



Wire Conduit - Flex Split

Black 1/2" x 100' Boxed **86634 (1)**

Black 1/2" x 4' **85634 (1)**

Black 3/4" x 3' **85636 (1)**

Black 3/8" x 100' Boxed **86632 (1)**

Black 3/8" x 5' **85632 (1)**

Red 1/2" x 4' **86646 (1)**

Red 3/8" x 5' **86645 (1)**

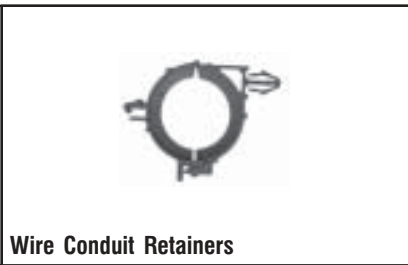

Wire Conduit Retainers

1" **85658 (1)**

1/2" **85656 (2)**

3/4" **85657 (2)**

7/16" **85655 (2)**

OE Mazda Style **85659 (2)**

85603 (1)



Wire Conduit Tee

One size fits all. Special adapter plugs permits 3/8", 1/2" and 3/4" conduit to fit tee.

85603 (1)



Wire Spiral Tubing

Spirally cut, expandable plastic. Allows easy wire breakout or entry at any location.

Black 3/8" x 10' **86135 (1)**

Clear 1/2" x 3' **85676 (1)**

Clear 1/4" & 3/8" **86140 (2)**

Clear 1/4" x 5' **85672 (1)**

Clear 1/4", 3/8" & 1/2" **85644 (3)**

Clear 3/8" x 4' **85674 (1)**

85648 (1)



Wire Tie & Clamp Kit

Includes 4", 6" & 8" wire ties, assorted grommets and nylon clamps.

85648 (1)

86693 (1)



Wiring Kit

Includes items needed to perform that quick wiring project! Contains loom, wire, tape, wire ties, fuse holder, clamps, grommets and terminals.

86693 (1)



Wire Tie Mounts

#6 Screw Mount (shown) **85642 (5)**

Adhesive Back **85640 (5)**



Relays allow a small amperage switch to drive a large amperage component (example: horn) - also used when a large amperage component remains on for a long period of time (example: radiator cooling fan).



Pulse FX™ now offers red, blue, yellow and white wire conduit, see page 93.

Electrical - Pulse FX™ - Sockets - Lighting



84790 (2) *Driving*
reNEW

High Temperature Headlamp - Standard

84791 (2) *Driving*
reNEW

High Temperature 9004/9007 Bulb

84792 (2) *Driving*
reNEW

High Temperature 9005 Bulb

84793 (2) *Driving*
reNEW

High Temperature 9006 Bulb



High wattage Headlamp Bulbs generate extra heat and will damage OE sockets - always install high temp headlamp sockets for added protection.



Electrical - Pulse FX™ - Switches



84820 (1) *Driving*
reNEW

Engine Start Illuminating Push Button

Ignite your engine! Universal with interchangeable button covers in red, blue & yellow. Turn your key and let the starter button do the rest. Can be wired to starter system or simply connected to dash lights for effect. Replace bulb 1891.

84820 (1)

Driving
reNEW

Rocker Full Glow - Oval Style Aluminum

30 Amp (360 watts). Illuminates when "on". Use .250" disconnect terminals. Drill 1/2" hole or use with panel 85925.

- Amber Glow **84872 (1)**
- Blue Glow **84871 (1)**
- Green Glow **84873 (1)**
- Red Glow **84870 (1)**

Driving
reNEW

Rocker Full Glow - Round Style

25 Amp (300 watts). Illuminates when "on". Use .250" disconnect terminals. Drill 1" hole or use with panel 85993.

- Blue Body/Blue Glow **84855 (1)**
- Red Body/Red Glow **84854 (1)**
- Yellow Body/Amber Glow **84856 (1)**

84815 (1) *Driving*
reNEW

Racing Style "Kill" Switch

20 Amp (240 watts). Switch with aircraft safety guard: lift cover and flip switch to turn on, flip down cover for quick off. Perfect master "arming" switch for ignition, nitrous, etc.

Red Cover **84815 (1)**

Driving
reNEW

Rocker Full Glow - Rectangular Style

Amp 25 (300 watts). Illuminates when "on". Use .250" disconnect terminals. Use with panel 85927.

- Blue Body/Blue Glow **84835 (1)**
- Red Body/Red Glow **84834 (1)**
- Yellow Body/Amber Glow **84836 (1)**

Driving
reNEW

Rocker LED Glow - Oval Style

30 Amp (360 watts). Illuminates when "on". Use .250" disconnect terminals. Drill 1/2" hole or use with panel 85925.

- Blue Body/Blue LED **84845 (1)**
- Red Body/Red LED **84844 (1)**
- Yellow Body/Amber LED **84846 (1)**

Visit us at www.motormite.com

Electrical - Pulse FX™ - Switches (continued)



Rocker Full Glow - Oval Style

30 Amp (360 watts). Illuminates when "on". Use .250" disconnect terminals. Drill 1/2" hole or use with panel 85925.

Blue Body/Blue Glow	84865 (1)
Red Body/Red Glow	84864 (1)
Yellow Body/Amber Glow	84866 (1)



Rocker LED Glow - Round Style

25 Amp (300 watts). Illuminates when "on". Use .250" disconnect terminals. Drill 1" hole or use with panel 85993.

Blue Body/Blue LED	84885 (1)
Red Body/Red Glow	84884 (1)
Yellow Body/Amber LED	84886 (1)



Toggle Full Glow Switches

20 Amp (240 watts). Illuminates when "on". Use .188" disconnect terminals. Drill 13/16" hole or use with panel 85994.

Blue Body/Blue Glow	84905 (1)
Red Body/Red Glow	84904 (1)



Toggle Full Glow Switches

20 Amp (240 watts). Illuminates when "on". Use .188" disconnect terminals. Drill 13/16" hole or use with panel 85994.

Yellow Body/Amber Glow	84906 (1)
------------------------	------------------



Mounting Panels are available for most switches, see page 58.

Electrical - Pulse FX™ - Terminals

Conduct-Tite!

- Gold plated terminals for maximum conductivity
- The perfect connection for high performance audio systems
- Vinyl Insulated Terminals include both black and red sleeves



Butt Connectors

12-10 Ga. Yellow	84512 (10)
16-14 Ga. Blue	84511 (10)
22-18 Ga. Red	84510 (10)



Quick Disconnects

12-10 Ga. Yellow Female .110"	84553 (7)
12-10 Ga. Yellow Female .187"	84552 (7)
12-10 Ga. Yellow Female .250"	84550 (7)
16-14 Ga. Blue Female .110"	84547 (10)
16-14 Ga. Blue Female .187"	84546 (10)
16-14 Ga. Blue Female .250"	84542 (10)
22-18 Ga. Red Female .110"	84541 (10)
22-18 Ga. Red Female .187"	84540 (10)
22-18 Ga. Red Female .250"	84537 (10)



Ring Terminals

12-10 Ga. Yellow 3/8"	84533 (10)
16-14 Ga. Blue 1/4"	84523 (10)
22-18 Ga. Red #10	84517 (10)



For best results, use Ratcheting Crimper #86595, see page 78.

NEW PRODUCT HOTLINE - 1-800-336-3575

E

Electrical - Pulse FX™ - Terminals (continued)

84615 (4)

Driving
TECHNEW



Vinyl Insulated Banana Terminals

16-12 Ga.

84615 (4)

Driving
TECHNEW



Vinyl Insulated Flat Pin Terminals

12-10 Ga.

84618 (4)

16-14 Ga.

84617 (4)

Driving
TECHNEW



Vinyl Insulated Snap Spade Terminals

12-10 Ga.

84620 (8)

16-14 Ga.

84619 (8)

84614 (10)

Driving
TECHNEW



Vinyl Insulated Ring Terminals

8 Ga. 3/8"

84614 (10)

84616 (4)

Driving
TECHNEW



Vinyl Insulation Pin Terminals

16-14 Ga.

84616 (4)

How to Install Car Stereo & Amplifier

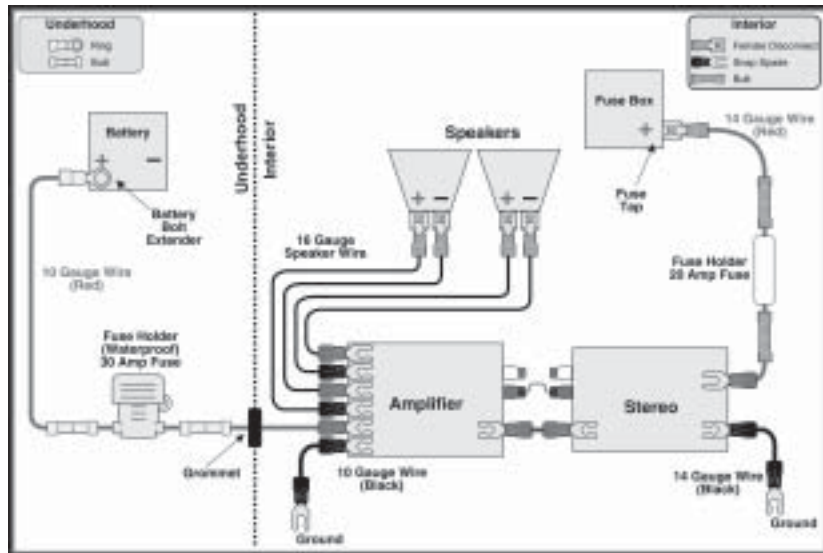

PARTS LISTING

Description	Part Number
Speaker Wire - 16 AWG	85756
Primary Wire - Red 14 AWG	85716
Primary Wire - Black 14 AWG	85718
Underhood Ring Terminal 12-10 5/16" or 3/8"	85216 or 85217
Underhood Butt Connector 12-10	85238
Primary Wire - Red 10 AWG	85700
Primary Wire - Black 10 AWG	85702
Fuse Holder	84938
Fuse Holder - Waterproof	84939
Fuse Tap - Glass Type or Blade Type	85602 or 85606
Grommet	85604
Battery Bolt Extender - Top Post or Side Post	84397, 84398 or 84399
Audio-Crimp Butt Connector 16-14	84511
Audio-Crimp Female Disconnect 16-14 .250"	84542
Audio-Crimp Female Disconnect 16-14 .187"	84546
Audio-Crimp Snap Spade Connector 16-14	84619 (2 packs)
Audio-Crimp Snap Spade Connector 12-10	84620

Note: You will need two #10 sheet metal screws for the ground connections. Additional types of gold plated Audio-Crimp terminals may be required for your specific sound system - review selection of flat pin connectors & bananas plugs on the PULSE FX panel. Also, you will need one 20 Amp (glass) fuse and one 30 Amp (blade) fuse.

Visit us at www.motormite.com

Electrical - Pulse FX™ - Wiring Accessories

Conduct-Title!

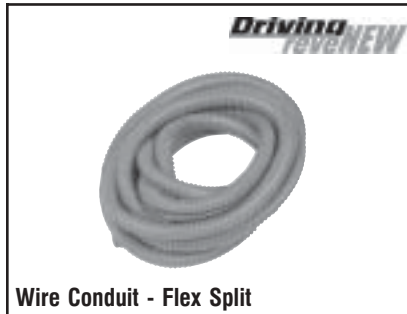

Wire Conduit - Flex Split

10' of flame retardant wire protection. Split seam provides easy insertion and removal without disconnecting wire from harness.

Blue - 3/4"	86661 (1)
Blue - 3/8"	86651 (1)
Red - 3/4"	86660 (1)
Red - 3/8"	86650 (1)
White - 3/8"	86653 (1)
Yellow - 3/4"	86662 (1)
Yellow - 3/8"	86652 (1)



Wire Sleeving - Expandable

Blue	86671 (1)
Clear	86674 (1)
Red	86670 (1)
Silver	86673 (1)
Yellow	86672 (1)

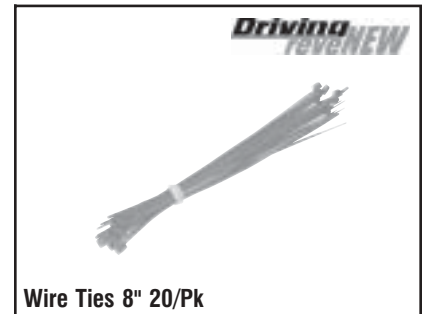

Wire Ties 8" 20/Pk

Blue	83901 (20)
Red	83900 (20)
White	83903 (20)
Yellow	83902 (20)



Wire Tubing - Spiral

Blue	86137 (1)
Red	86136 (1)
Yellow	86138 (1)



Wiring Accessory Kits

Everything you need to organize and protect underhood and interior wires. Includes 10' wire conduit, 9' expandable sleeving, 10' spiral tubing, 20 wire ties, heat shrink tubing, wire loom clips and tees.

Blue	86451 (1)
Red	86450 (1)
Yellow	86452 (1)

- Offer your customers distinctive underhood styling in red, yellow and blue — the most sought after colors by the sport compact market.
- Allows customers to coordinate underhood with exterior colors.
- Protect and organize Wiring Harnesses and Hoses.



E