

Electrical - Terminals - Bullet Connectors



UNDERHOOD vs. INTERIOR Terminals

UNDERHOOD Connection™

- All vehicles come from the factory with sealed underhood connectors to prevent shorts and corrosion.
- Use underhood terminals under the hood, under the vehicle, for watercraft, motorcycles, off-road vehicles and trailers - anywhere moisture is present.

• Easy to install:



Strip the wire



Insert the wire



Crimp the wire



Apply heat

INTERIOR Connection™

- Use interior terminals in the interior, under the seat or in the trunk - anywhere moisture is not present.
- Easy to install:



Strip the wire



Insert the wire



Crimp the wire

- Use the right terminal for the application.



Underhood-Connection™
(Waterproof)



Interior-Connection™
(Standard PVC)

Gauge	Color	Size/Gender	Underhood-Connection™		Interior-Connection™		
			Low Pack	Mid Pack	Low Pack	Mid Pack	High Pack
22-18	Red	.157" Female			85530 (5)		
22-18	Red	.157" Male			85531 (5)		
22-18	Red	.157" Male/Female Set				85474 (10)	
16-14	Blue	.157" Female	85232 (2)	85268 (10)	85532 (5)	85432 (14)	85427 (50)
16-14	Blue	.157" Male	85233 (2)	85269 (10)	85533 (5)	85433 (20)	85428 (100)
16-14	Blue	.157" Male/Female Set			85434 (10)	85429 (20)	85448 (50)
16-14	Blue	.188" Female			86532 (5)	85456 (13)	
16-14	Clear	.188" Female Double			85575 (2)	85475 (6)	85482 (12)
16-14	Blue	.188" Male			86534 (5)		85457 (25)

Electrical - Terminals - Butt Connectors



Underhood-Connection™
(Waterproof)



Double Crimp™
(Heavy-duty Nylon)



Interior-Connection™
(Standard PVC)

Gauge	Color	Size/Gender	Underhood-Connection™		Double Crimp™	Interior-Connection™		
			Low Pack	Mid Pack		Low Pack	Mid Pack	High Pack
Assortment	Mixed	Mixed				85480 (16)		
22-18	Red		85235 (2)	85239 (10)	84101 (10)	85535 (5)	85435 (21)	85497 (100)
16-14	Blue		85236 (2)	85240 (10)	84102 (10)	85536 (5)	85436 (21)	85498 (100)
12-10	Yellow		85237 (2)	85241 (7)	84103 (7)	85537 (5)	85437 (13)	85499 (50)



Double-Crimp™

- Transparent nylon allows for proper insertion and crimp of wire
- Crimps on the wire and the insulator—providing a permanent connection
- Maximum connection for high vibration applications



Underhood Connection™

- Heat-shrinkable insulation provides weatherproof seal
- For best results, first crimp terminal and then apply heat with a mini torch or heat gun
- Ideal for moisture-prone applications

Visit us at www.motormite.com

Electrical - Terminals - Butt Connectors-Step Down

Conduct-Tite!



(Standard PVC)

Gauge	Interior-Connection™	
	Low Pack	
16-22 to 14-18	85696 (2)	
12-16 to 10-14	85697 (2)	
8-12 to 10	85698 (2)	
6 to 8	85699 (2)	



The Step Down Butt Connector is the perfect solution when two wires need to be inserted in one end of a splice and a single wire in the other end.

Electrical - Terminals - Closed End Connectors

Conduct-Tite!



(Standard PVC)

Gauge	Color	Interior-Connection™		
		Low Pack	Mid Pack	High Pack
22-14	Clear	85590 (5)		
18-10	Clear	85591 (5)	85491 (12)	85493 (80)
12-10	Clear	85592 (5)	85492 (10)	85494 (40)



Closed end connectors are used in a wide variety of situations to "pigtail" or tie together two or more wires.

Electrical - Terminals - Disconnects

Conduct-Tite!



Use Double-Crimp™ Flag Disconnects for circuits with limited space - 90° shape permits low profile wiring.

Female Underhood
(Waterproof)



Male Interior
(Standard PVC)



To reduce risk of electrical shorts, use Insulated Disconnects. See page 68.

Gauge	Color	Size/Gender	Underhood-Connection™		Interior-Connection™		
			Low Pack	Mid Pack	Low Pack	Mid Pack	High Pack
Assorted	Mix	.250" Male/ Female Mix				85481 (18)	
22-18	Red	.110" Female			85544 (5)		
22-18	Red	.187" Female			85545 (5)		
22-18	Red	.187" Male			85548 (5)		
22-18	Red	.250" Female	85250 (2)	85254 (10)	85550 (5)	85450 (20)	85485 (100)
22-18	Red	.250" Male			85551 (5)	85451 (20)	85486 (100)
22-18	Red	Mix			85476 (6)		
16-14	Blue	.187" Female			85546 (5)	85446 (20)	85483 (100)
16-14	Blue	.187" Male			85549 (5)		
16-14	Blue	.250" Female	85252 (2)	85255 (10)	85552 (5)	85452 (20)	85496 (100)
16-14	Blue	.250" Male			85553 (5)	85453 (20)	85487 (100)
16-14	Blue	.250" Male/ Female Set				85449 (50)	
12-10	Yellow	.250" Female	85253 (2)	85256 (7)	85554 (5)	85454 (14)	85488 (50)
12-10	Yellow	.250" Male			85555 (5)	85455 (14)	85489 (50)
12-10	Yellow	.375" Female			85547 (5)	85447 (7)	85484 (50)

NEW PRODUCT HOTLINE - 1-800-336-3575

E

Electrical - Terminals - Disconnects Insulated

Conduct-Tite!



Underhood-Connection™
(Waterproof)



Interior-Connection™
(Heavy-duty Nylon)

Gauge	Color	Size/Gender	Underhood-Connection™		Interior-Connection™		
			Low Pack	Mid Pack	Low Pack	Mid Pack	High Pack
22-18	Red	.250" Female	85258 (2)	85243 (10)	85556 (5)		
22-18	Red	.250" Male	85257 (2)	85242 (10)		85557 (5)	
22-18	Red	.250" Male/Female Set			85560 (4)	85460 (10)	85490 (20)
16-14	Blue	.250" Female	85260 (2)				
16-14	Blue	.250" Female	84151 (7)				
16-14	Blue	.250" Male	85259 (2)		85559 (5)	85465 (14)	
16-14	Blue	.250" Male/Female Set			85561 (4)	85461 (10)	
16-14	Blue	.250" Male/Female Set					85470 (20)
16-14	Blue	.250" Female			85558 (5)	85471 (12)	85469 (50)
12-10	Yellow	.250" Female	85263 (2)		85562 (5)	85472 (10)	
12-10	Yellow	.250" Male	85262 (2)		85563 (5)	85466 (10)	
12-10	Yellow	.250" Male/Female Set			86564 (4)		

Electrical - Terminals - Flags

Conduct-Tite!

- Transparent nylon allows for proper insertion and crimp of wire
- Crimps on the wire and the insulator - providing a permanent connection
- Maximum connections for high vibration applications

Driving REVENUE



(Heavy-duty Nylon)

Gauge	Color	Size/Gender	Interior-Connection™
			Double-Crimp™
22-18	Red	.250" Female	84170 (10)
16-14	Blue	.250" Female	84171 (10)
12-10	Yellow	.250" Female	84172 (7)

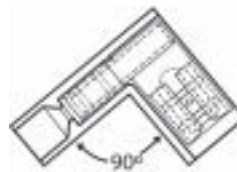

Electrical - Terminals - Hook Connectors

Conduct-Tite!



(Standard PVC)

Gauge	Color	Size/Gender	Interior-Connection™	
			Low Pack	Mid Pack
16-14	Blue	#10	85529 (5)	
16-14	Blue	#6	85527 (5)	
16-14	Blue	#8	85528 (5)	
16-14	Blue	Assortment		85478 (20)

Visit us at www.motormite.com

Electrical - Terminals - Quick Splices



Gauge	Color	Interior-Connection™		
		Low Pack	Mid Pack	High Pack
22-18	Red	85565 (2)	85463 (7)	85467 (25)
18-14	Blue	85564 (3)	85464 (7)	85495 (25)
18-14	White	85577 (2)		
12-10	Brown	86578 (2)		
12-10	Yellow	85566 (2)		
Assorted				86503 (21)

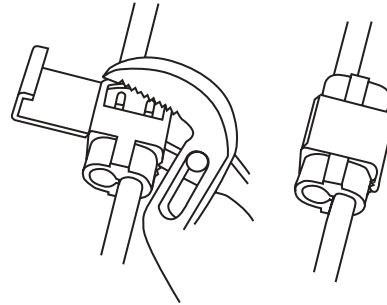

Electrical - Terminals - Ring Connectors



If unsure of screw size, use Multistud Rings, page 70.



Underhood-Connection™
(Waterproof)



Interior-Connection™
(Standard PVC)



Double Crimp™
(Heavy-duty Nylon)

Gauge	Color	Size/ Gender	Underhood-Connection™		Interior-Connection™			Double Crimp™
			Low Pack	Mid Pack	Low Pack	Mid Pack	High Pack	
Assorted	Mix	Mix				85477 (18)		
22-18	Red	#10	85202 (2)	85203 (10)	85502 (5)	85402 (21)	85401 (100)	84112 (10)
22-18	Red	#6	85200 (2)		85500 (5)			
22-18	Red	#8	85201 (2)		85501 (5)			
22-18	Red	1/4"			85503 (5)			
22-18	Red	3/8"			85505 (5)			
22-18	Red	5/16"			85504 (5)	85438 (15)	85439 (100)	
16-14	Blue	#10	85208 (2)	85220 (10)	85508 (5)	85408 (18)	85404 (100)	
16-14	Blue	#6	85206 (2)		85506 (5)			
16-14	Blue	#8	85207 (2)		85507 (5)	85407 (20)	85403 (100)	
16-14	Blue	1/4"	85209 (2)	85210 (10)	85509 (5)	85409 (16)	85405 (100)	84123 (10)
16-14	Blue	3/8"			85511 (5)	85411 (14)	85406 (100)	
16-14	Blue	5/16"			85510 (5)	85441 (12)	85442 (100)	
12-10	Yellow	#10	85214 (2)	85204 (7)	85514 (5)	85414 (13)	85410 (100)	
12-10	Yellow	#6			85512 (5)			
12-10	Yellow	#8	85213 (2)		85513 (5)	85444 (14)	85443 (100)	
12-10	Yellow	1/2"			85518 (5)			
12-10	Yellow	1/4"	85215 (2)	85211 (7)	85515 (5)	85415 (11)	85430 (50)	84133 (7)
12-10	Yellow	3/8"	85217 (2)	85212 (7)	85517 (5)	85417 (11)	85413 (50)	84135 (7)
12-10	Yellow	5/16"	85216 (2)	85205 (7)	85516 (5)	85445 (11)	85440 (100)	

NEW PRODUCT HOTLINE - 1-800-336-3575



Electrical - Terminals - Rings - Multi-Stud



(Heavy-duty Nylon)

- Special ring terminal fits stud size #6, #8 and #10
- Crimps on the wire and the insulator - providing a permanent connection
- Maximum connection for high vibration applications

Gauge	Color	Size/Gender	Interior-Connection™
			Double Crimp™
22-18	Red	#6, 8 & 10	84160 (10)
16-14	Blue	#6, 8 & 10	84161 (10)
12-10	Yellow	#6, 8 & 10	84162 (7)

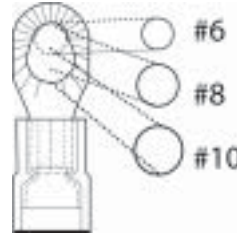

Electrical - Terminals - Rings - Star



(Standard PVC)

Make a Good Connection!!

Gauge	Color	Size/Gender	Interior-Connection™
			Low Pack
22-18	Red	#10	85540 (4)
22-18	Red	#6	85538 (4)
22-18	Red	#8	85539 (4)
16-14	Blue	#10	85543 (4)
16-14	Blue	#6	85541 (4)
16-14	Blue	#8	85542 (4)



The Star Ring is a serrated ring that is mainly used for grounding. When you tighten down on the serrated edges actually pierce through paint or other coatings and bite into the metal to insure a good connection or ground!

Electrical - Terminals - Spade Connectors



(Waterproof)



(Standard PVC)

Gauge	Color	Size/Gender	Underhood-Connection™	Interior-Connection™		
			Low Pack	Low Pack	Mid Pack	High Pack
Assorted	Mix	#8			85479 (20)	
22-18	Red	#10	85228 (2)	85521 (5)		
22-18	Red	#6		85519 (5)		
22-18	Red	#8		85520 (5)	85420 (22)	85416 (100)
16-14	Blue	#10	85223 (2)	85523 (5)	85423 (20)	85419 (100)
16-14	Blue	#6	85219 (2)	85526 (5)	85426 (22)	85424 (100)
16-14	Blue	#8		85522 (5)	85422 (22)	85418 (100)
12-10	Yellow	#10	85225 (2)	85525 (5)	85425 (13)	85421 (50)
12-10	Yellow	#8		85524 (5)		
12-10	Yellow	1/4"		85578 (5)		

Visit us at www.motormite.com

Electrical - Terminals - Specialty

Conduct-Tite!

85412 (6)



Interior Disconnect Adapter Assortment

Includes two each of Male Flat Tabs .250", Male Piggybacks and Male Chair Adapters.

85612 (6)



Interior Disconnect Assortment

Includes four .250" 16-14 Ga. Female Disconnects and two Fully Insulated Double Male Disconnects.

85576 (2)

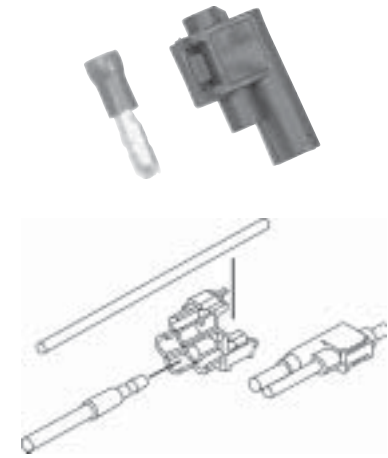

Interior Splice Tap Bullet Connector

22-18 Ga. Accepts 16-14 Ga. Male Bullet .157".

85431 (12)



Interior Disconnect Adapter Assortment

Includes two each of .250" Fully Insulated Double Male, Double Male Piggybacks, Double Male Chairs, Double Male Flats, 16-14 Ga. & 22-18 Ga. Disconnects.

85574 (3)



Interior Disconnect Male Double

22-18 Ga. With .250" tabs.

85613 (10)



Interior Disconnect Piggybacks

Double Male with .250" tabs.

85614 (7)



Interior Piggyback Disconnect Chair Adapter

Double Male with .250" tabs.

TWIST-CONNECT™

No Strip • No Crimp Reusable Connectors

**Driving
RENEW**



Available in the 3 most popular automotive wire sizes: 20-18, 16-14 and 12-10. Color-coded to help select the proper connector size.



100% copper connector insures absolute conductivity within durable nylon housing.

**Twist-Connect™
Traditional Package**

20-18 Ga **84335 (3)**

16-14 Ga **84336 (3)**

12-10 Ga **84337 (3)**

Assortment **84338 (10)**

**Twist-Connect™
Retail Package**

20-18 Ga **84345 (10)**

16-14 Ga **84346 (10)**

12-10 Ga **84347 (10)**

Assortment **84348 (10)**

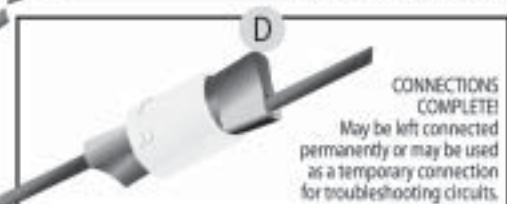
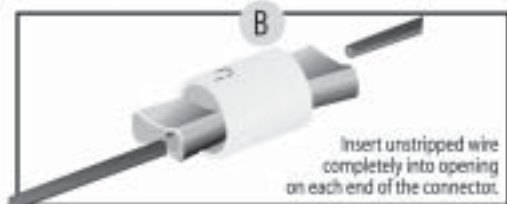
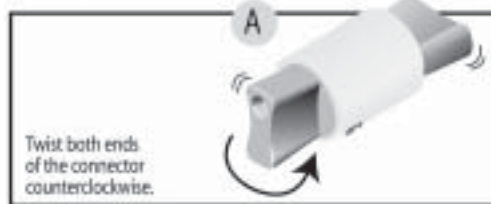

Patent pending

NEW PRODUCT HOTLINE - 1-800-336-3575

E

Electrical - Terminals - T-Tap Connectors

Conduct-Title!

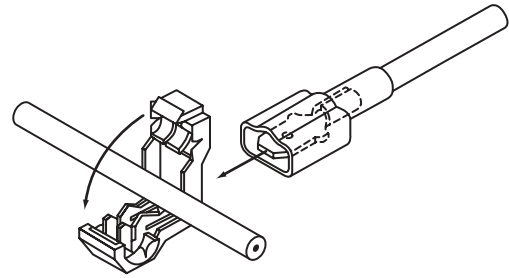

Gauge	Color	Interior-Connection™		
		Low Pack	Mid Pack	High Pack
22-18	Red	85567 (2)		
18-14	Blue	85568 (2)	85468	85473
12-10	Yellow	85569 (2)		

Electrical - Terminals - Wire Nuts

Conduct-Title!



Gauge	Color	Interior-Connection™	
		Low Pack	Mid Pack
Assorted	Mix		85688 (18)
22-16	Gray	85571 (3)	
22-14	Orange	85572 (3)	
22-14	Blue	85579 (3)	
20-16	Yellow	85570 (3)	
16-14	Red	85600 (2)	

Electrical - Terminals - 3- and 4-Way Connectors

Conduct-Title!



(Standard PVC)

Gauge	Color	Interior-Connection™
22-18	Red	85664 (4)
16-14	Blue	85582 (4)
12-10	Yellow	85583 (4)



(Standard PVC)

Gauge	Color	Interior-Connection™
22-18	Red	85584 (4)
16-14	Blue	85585 (4)
12-10	Yellow	85586 (4)

Electrical - Terminals - Kits

Conduct-Title!

- Multiple size value assortments allow you to always have the right "Interior" terminals in your toolbox or trunk

86694 (1)



100-Piece Kit

Contains a variety of connectors for every electrical project. Keep terminals organized in this plastic storage case.

85691 (1)



100-Piece Kit with Crimper

In attractive, organized storage case.

85693 (1)



149-Piece Assortment

Ideal kit for interior wiring and connecting. Contained in reusable slide blister.

Visit us at www.motormite.com

Electrical - Terminals - Kits (continued)

85694 (1)

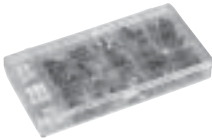

175-Piece Kit

Contains a variety of connectors. Sturdy plastic storage unit provides easy access.

85695 (1)



208-Piece Kit

Contents are organized in dual-sided carrying case for easy retrieval. Includes crimper, test leads, wire, tape, connectors and more.

86690 (1)

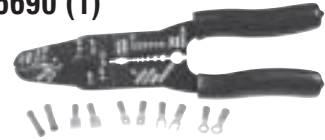

25-Piece Assortment with Deluxe Crimper

Terminal assortment with a heavy duty crimper for professional projects.

85573 (1)



33-Piece Assortment

Includes butts, rings, disconnects, bullets and quick splices.

85689 (1)

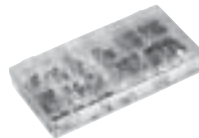

80-Piece Kit

Contained in refillable, clear plastic storage case. Terminals contained in refillable, clear plastic storage case.

86500 (1)



Terminal Assortments - 22-18 Ga.

56 pieces of 22-18 Ga. Terminals. Includes an assortment of butt connectors, rings, spades, disconnects for interior electrical applications.

86501 (1)



Terminal Assortments - 16-14 Ga.

61 Pieces of 16-14 Ga. Terminals. Includes an assortment of butt connectors, rings, spades, disconnects for interior electrical applications.

86502 (1)



Terminal Assortments - 12-10 Ga.

36 Pieces of 12-10 Ga. Terminals. Includes an assortment of butt connectors, rings, spades, disconnects for interior electrical applications.

86592 (1)



Wire Nuts & Closed End Connectors

Electrical - Terminals - Technician

Conduct-Tite!

- Save time and money...only replace the broken terminal, not the entire harness
- Use as replacement for GM, Ford & Chrysler connectors/terminals.
- A must for anyone working on today's hi-tech on-board engine management systems or for retro-fitting systems on older vehicles.

Do you have the Extraction & Installation Tools?

Extraction

Use Extractor Tools (85360) for proper terminal extraction from insulating housing.



Installation

Must use OE Terminal Crimping Tool (85363) - specifically designed with cavities to properly crimp and roll OE style terminals.



85300 (5)



GM 56 Series™

18-14 Gauge Male Terminal.

85301 (2)



GM 56 Series™

Insulated Housing.

85303 (5)



GM Weather Pack™ Series

20-18 Gauge Tin Plated Brass Male.

GM Weather Pack is a registered trademark of the Packard Electric Division, General Motors Corporation.

NEW PRODUCT HOTLINE - 1-800-336-3575

E