

# Electrical - Switches - Push/Pull



**85980 (1)**

**Push Button Momentary-On**

16 Amp (192 watts). Use .250" disconnect terminals. Drill 1/2" hole or use with panel 85295.

**85980 (1)**

**85981 (1)**

**Push Button Momentary-On Heavy Duty**

European Style. 20 Amp (240 watts). Set screw terminals. Fits in 1" hole for installation.

**85981 (1)**

**Push Button On-Off**

**LED**

16 Amp (192 watts). Glow: Illuminates when "on". Use .250" disconnect terminals. Drill 1/2" hole or use with panel 85925.

LED Glow Green **85986 (1)**  
 LED Glow Red **85987 (1)**  
 Non Glow **85985 (1)**

**Push/Pull Brass**

15 Amps (180 watts). Drill 3/8" hole for easy installation.

3 Position Screw Terminals **86914 (1)**  
 On-Off Function Screw Terminals **86912 (1)**

**85989 (1)**

**Push/Pull Fused Headlight**

15 Amp (180 watts). 3-Position switch controls parking lights and headlights. Includes 15 Amp fuse to protect circuit. Drill 7/16" hole.

**85989 (1)**

**Push/Pull Glow**

16 Amp (192 watts). Illuminates when "on". Use .250" disconnect terminals. Drill 1/2" hole or use with panel 85925.

Amber **85952 (1)**  
 Blue **85954 (1)**  
 Green **85953 (1)**  
 Red **85951 (1)**

**Push/Pull Metal**

On-Off function with screw terminals. Drill 7/16" hole for quick installation.

16 Amp (192 watts) **85955 (1)**  
 75 Amp (900 watts) **86916 (1)**

**85933 (1)**

**Push-Pull European Style**

15 Amp (180 watts). Set screw terminals. Fits in 5/16" hole.

On-Off Function **85933 (1)**

All circuits should include an in-line fuse holder, see page 86.

**Do you know which switch to buy for your project?**

Determine the amperage or wattage for the accessory or component you are controlling.

Example: A pair of 55 Watt driving lights = 110 Watts - requires a 10 Amp switch. (110 Watts divided by 12 Volts equals 9.2 Amps)

Use the chart to the right to calculate the correct amperage rating for your switch.

Total Circuit Watts	Switch Amps
Up to 72	6
Up to 120	10
Up to 192	16
Up to 240	20
Up to 300	25
Up to 360	30
Up to 420	35
Up to 600	50
Up to 720	60
Up to 900	75



# Electrical - Switches - Rocker

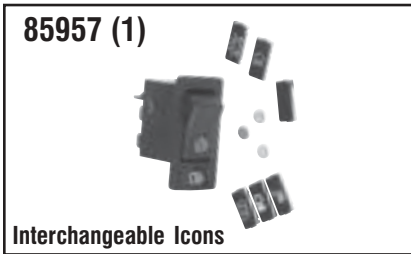

**85957 (1)**  
**Interchangeable Icons**

20 Amps (240 watts). Use with .250" disconnect terminals.

Glow Dot 3 Pin w/Colored Lenses

**85957 (1)**

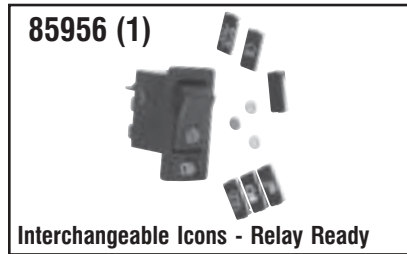

**85956 (1)**  
**Interchangeable Icons - Relay Ready**

20 Amps (240 watts). Use with .250" disconnect terminals.

Glow Dot 4 Pin w/Colored Lenses

**85956 (1)**



**LED Glow - Oval Style**

30 Amp (360 watts). Illuminates when "on". Use .250" disconnect terminals. Drill 1/2" hole or use with panel 85925.

Black Body/Amber LED **84842 (1)**  
Black Body/Blue LED **84841 (1)**  
Black Body/Red LED **84840 (1)**



**LED Glow - Round Style**

25 Amp (300 watts). Illuminates when "on". Use .250" disconnect terminals. Drill 1" hole or use with panel 85993.

Black Body/Amber LED **84882 (1)**  
Black Body/Blue LED **84881 (1)**  
Black Body/Red LED **84880 (1)**

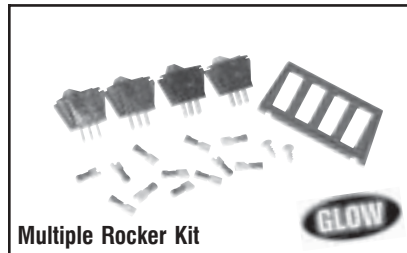

**Multiple Rocker Kit**

Includes multiple rectangular rocker switches (20 Amps each), disconnect terminals, panel and screws.

Four Switches: Red, Blue, Amber & Green **86923 (1)**  
Two Switches - Red & Amber **86921 (1)**

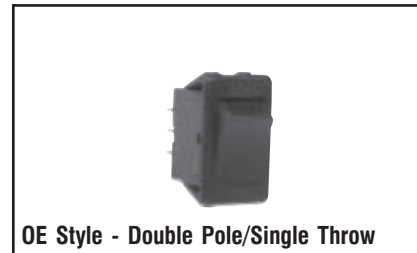

**OE Style - Double Pole/Single Throw**

20 Amp (240 watts). Use .250" disconnect terminals. Use with panel 86927.

On/Off Function **86910 (1)**  
On/On Function **86911 (1)**



**OE Style - Glow**

20 Amp (240 watts). Illuminates when "on". Use .250" disconnect terminals. Use with panel 86927.

Amber **86901 (1)**  
Blue **86902 (1)**  
Green **86903 (1)**  
Red **86900 (1)**



**OE Style - LED**

20 Amp (240 watts). Illuminates when "on". Use .250" disconnect terminals. Use with panel 86927.

Amber **86905 (1)**  
Green **86907 (1)**  
Red **86904 (1)**



**Rectangular Style**

20 Amp (240 watts). Glow: Illuminates when "on". Use .250" disconnect terminals. Use with panel 85927.

Amber Glow **85921 (1)**  
Blue Glow **85922 (1)**  
Green Glow **85923 (1)**  
Non-Glow Black **85924 (1)**  
Red Glow **85920 (1)**



Pulse FX™ now offers red, blue, yellow and aluminum colored switches, see pages 90-91.

Visit us at [www.motormite.com](http://www.motormite.com)

## Electrical - Switches - Rocker (continued)

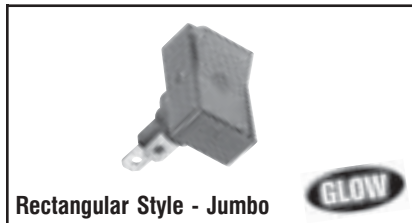

**Rectangular Style - Jumbo**

20 Amp (240 watts). Glow: Illuminates when "on". Use .250" disconnect terminals. Drill 1/2" hole or use with panel 85925.

Amber Glow	<b>85946 (1)</b>
Non-Glow Black	<b>85949 (1)</b>
Blue Glow	<b>85947 (1)</b>
Green Glow	<b>85948 (1)</b>
Red Glow	<b>85945 (1)</b>



**Rectangular Style - Mini**

10 Amp (120 watts). Glow: Illuminates when "on". Use .187" disconnect terminals. Use with panel 85992.

Amber Glow	<b>85918 (1)</b>
Blue Glow	<b>85916 (1)</b>
Green Glow	<b>85917 (1)</b>
Red Glow	<b>85915 (1)</b>



**Rectangular Style - Mini**

10 Amp (120 watts). Use .187" disconnect terminals. Use with panel 85992.

Momentary On - Non-Glow Black	<b>85968 (1)</b>
Non-Glow Black	<b>85944 (1)</b>
On-Off-On Non-Glow Black	<b>85969 (1)</b>



**85950 (1)**

**Rectangular Style - Non-Glow Black**

20 Amp (240 watts). Use .250" disconnect terminals. Use with panel 85927.

On-Off-On **85950 (1)**



**DON'T FORGET!**

Mounting panels are available for most switches, see page 58.

**E**

## Electrical - Switches - Specialty

**Conduct-Titel**



**84863 (1)**

**4-N-1 Lens Switch™ - Oblong Style**

One switch body with 4 easy-to-change lenses. Patent pending.

30 Amp (360 Watts) **84863 (1)**

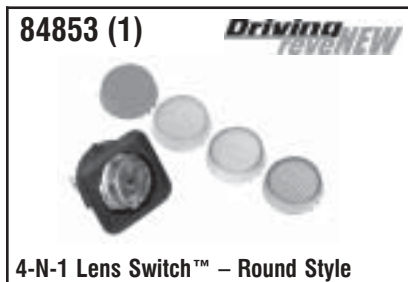

**84853 (1)**

**4-N-1 Lens Switch™ - Round Style**

One switch body with 4 easy-to-change lenses. Patent pending.

25 Amp (300 Watts) **84853 (1)**



**84907 (1)**

**4-N-1 Lens Switch™ - Toggle Style**

One switch body with 4 easy-to-change lenses. Patent pending.

20 Amp (240 Watts) **84907 (1)**

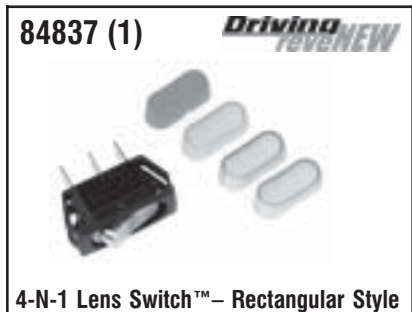

**84837 (1)**

**4-N-1 Lens Switch™ - Rectangular Style**

One switch body with 4 easy-to-change lenses. Patent pending.

25 Amp (300 Watts) **84837 (1)**

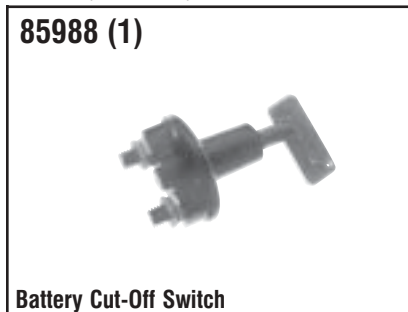

**85988 (1)**

**Battery Cut-Off Switch**

For either 12 or 24 volt systems. Key is removable in the off position only. Maximum load: 1,000 amps @ 12 volts for 10 seconds. 500 amps @ 24 volts for 10 seconds.

300 Amp Battery Isolator **85988 (1)**

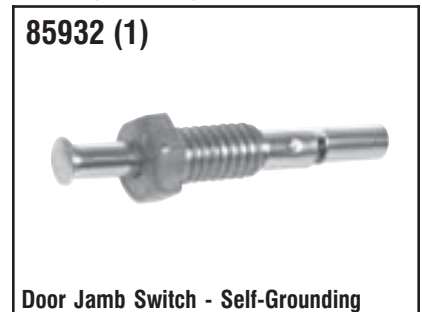

**85932 (1)**

**Door Jamb Switch - Self-Grounding**

12 Volt - On/Off. 10 Amps. 5/16" threads. OE style replacement.

**85932 (1)**

**NEW PRODUCT HOTLINE - 1-800-336-3575**

## Electrical - Switches - Specialty (continued)

85929 (1)



**Horn Button Flush Mount**

5 Amp. Mounts flush for universal applications. Includes hardware.

86929 (1)



**Horn Button Flush Mount w/Bracket**

5 Amp. Mounts flush. Includes bracket and hardware.

85930 (1)



**Horn Button - Universal**

5 Amp. Large button allows for accessible contact. Includes mounting hardware.

85931 (1)



**Door Jamb Switch - Universal**

12 Volt - Off/On. 10 Amp. Great for alarm, hood or trunk applications.

86913 (1)



**Starter Switches - Key Style Brass**

15 Amp. Complete with lock tumbler and keys. Ideal for all terrain vehicles, farm and marine. Three screw terminals. 7/8" diameter mounting stem.

85936 (1)



**Starter Switches - Key Style Metal**

15 Amp. Replaces broken or missing starter switch. Complete with lock tumbler and keys. Four stud terminals. 3/4" diameter mounting stem.

86915 (1)



**Starter Switch - Push Button Brass**

15 Amp. Moisture-and dust-proof rubber cap. Ideal for all terrain vehicles, farm and marine applications. 5/8" diameter mounting stem.

**4-N-1™  
Lens Switch**

One switch body with 4 easy-to-change lenses - color of choice snaps on in a flash.

Each switch includes 4 colored lenses:



Blue  
Red  
Amber  
Green

Available in these 4 styles



**Oblong  
Rocker**

Part #  
84863

**Rectangle  
Rocker**

Part #  
84837

**Round  
Rocker**

Part #  
84853

**Round  
Toggle**

Part #  
84907



### 4-N-1™ Lens Switches

- One switch body with 4 easy-to-change lenses.
- Blue, Red, Amber or Green Lens snaps on in a flash.
- Available in 4 different switch styles.

# Electrical - Switches - Specialty (continued)

85935 (1)



**Starter Switch - Push Button Metal**

15 Amp. Momentary-On. 5/8" diameter mounting stem.

85935 (1)

85984 (1)



**Starter Switch - Push Button Sealed**

60 Amp. Momentary-On. Heavy-duty die cast with silver/copper contacts for long life. Moisture-and dust-proof rubber cap.

85984 (1)

85937 (1)



**Wiring Kit - Switch**

Designed to operate with a maximum of two 55-watt halogen auxiliary lights or one 150-watt auxiliary light or any other similar powered circuit. Includes switch, wire, relay & terminals.

85937 (1)

## Wiring Diagram for 85937

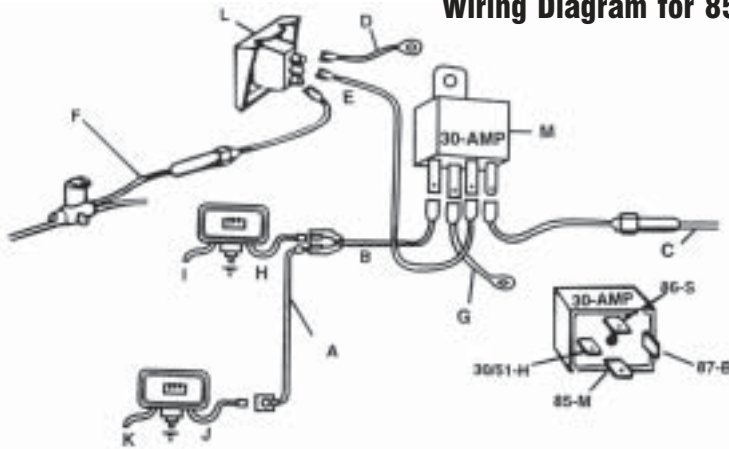

- A. BLUE Lamp jumper
- B. WHITE Relay to Lamp
- C. WHITE Power to Relay
- D. BLACK Ground Switch
- E. GREEN Switch to Relay
- F. RED Switch to Headlight
- G. BLACK Relay Ground
- H. Lamp Ground (not included in kit)
- J. Lamp Power (not included in kit)
- K. Lamp Ground (not included in kit)
- L. Switch

## HOW TO INSTALL: HORN

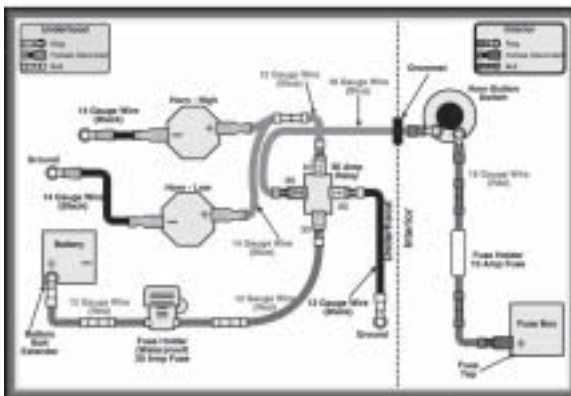

**NOTE:** Wire gauge, fuse amperage & switch amperage may be different for your horn – check horn amperage before you start your project.

**Note:** In addition to the parts to the right, you will need the following: four #10 sheet metal screws (three for the grounding connections and one to mount the relay) and one 10 Amp (glass) and one 30 Amp (blade) fuse.

### PARTS LISTING

Description	Part Number
Underhood Female Disconnect 22-18	85258
Interior Butt Connector 22-18	85435
Interior Ring Terminal 22-18 #8 Stud	85501
Interior Female Disconnect 22-18	85556
Primary Wire - Red 18 AWG	85732
Primary Wire - Blue 18 AWG	85736
Underhood Ring Terminal 16-14 #10 Stud	85208
Underhood Female Disconnect 16-14	85260 (2 packs)
Primary Wire - Black 14 AWG	85718
Primary Wire - Blue 14 AWG	85720
Underhood Ring Terminal 12-10 #10 Stud	85214
Underhood Ring Terminal 12-10 5/16" or 3/8"	85216 or 85217
Underhood Butt Connector 12-10	85236
Underhood Female Disconnect 12-10	85263 (2 packs)
Primary Wire - Red 12 AWG	85708
Primary Wire - Black 12 AWG	85710
Primary Wire - Blue 12 AWG	85712
Relay - 30 Amp	84601
Fuse Holder - Waterproof	84939
Fuse Tap - Glass Type or Blade Type	85602 or 85606
Grommet	85604
Fuse Holder - 10 Amp	85661
Battery Bolt Extender - Top Post or Side Post	84387, 84398 or 84399
Horn Button Switch - Flush or Bracket Mount	85929 or 85930

# Electrical - Switches - Toggle

**Conduct-Tite!**



**GLOW**

**Duck Bill - Glow**

20 Amp (240 watts). Illuminates when "on". Use .250" disconnect terminals. Drill 1/2" hole or use with panel 85925.

Amber	<b>85961 (1)</b>
Blue	<b>85962 (1)</b>
Green	<b>85963 (1)</b>
Red	<b>85960 (1)</b>

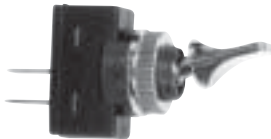

**Duck Bill - Non-Glow**

20 Amp (240 watts). Use .250" disconnect terminals. Drill 1/2" hole or use with panel 85925.

Black On-Off	<b>85964 (1)</b>
Black On-Off-On	<b>85967 (1)</b>
Chrome On-Off	<b>85966 (1)</b>



**85965 (1)**

**Duck Bill - Waterproof**

20 Amp (240 watts). Protects switch from dust and moisture. Use .250" fully insulated disconnect terminals. Drill 1/2" hole or use with panel 85925.

**85965 (1)**

**85970 (1)**



**Euro Style**

20 Amp (240 watts), Heavy Duty On-Off-On. Screw terminal connections. Drill 1/2" hole or use with panel 85925.

**85970 (1)**

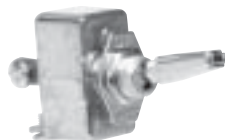

**Lever Chrome w/Screw Terminals**

Chrome construction. Screw terminal connection. Drill 1/2" for installation.

35 Amp (420 watts) - On-Off-On	<b>85983 (1)</b>
50 Amp (600 watts) - On-Off	<b>85904 (1)</b>



**Lever Extended Arm**

20 Amp (240 watts). Use .250" disconnect terminals. Drill 1/2" hole or use with panel 85925.

On-Off - Metal Staff	<b>85972 (1)</b>
On-Off - Plastic Staff	<b>85974 (1)</b>

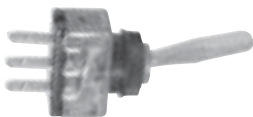

**GLOW**

**Lever Glow**

20 Amp (240 watts). Illuminates when "on". Use .250" disconnect terminals. Drill 1/2" hole or use with panel 85925.

Amber	<b>85911 (1)</b>
Blue	<b>85912 (1)</b>
Green	<b>85913 (1)</b>
Red	<b>85910 (1)</b>



**Driving TOBENEW**

**Lever LED - Metal Style**

**LED**

30 Amp (360 watts). Illuminates when "on". Use .250" disconnect terminals. Drill 1/2" hole or use with panel 85925.

Amber LED	<b>84896 (1)</b>
Blue LED	<b>84895 (1)</b>
Green LED	<b>84897 (1)</b>
Red LED	<b>84894 (1)</b>



**85909 (1)**

**Lever LED Indicator**

**LED**

30 Amp (360 watts). Illuminates when "on". Use .250" disconnect terminals. Drill 1/2" hole or use with panel 85925.

Red	<b>85909 (1)</b>
-----	------------------

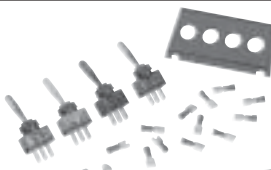

**GLOW**

**Lever Multiple Toggle Kit**

Includes multiple glow toggle switches (20 Amps each), disconnect terminals, panel and screws.

2 Switches: Red & Amber	<b>86920 (1)</b>
4 Switches: Red, Blue, Amber & Green	<b>86922 (1)</b>

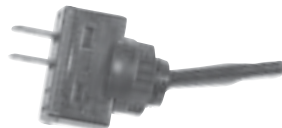

**Lever Plastic - Black**

20 Amp (240 watts). Use .250" female disconnects. Drill 1/2" hole or use with panel 85925.

Momentary-On Function	<b>85958 (1)</b>
On-Off Function	<b>85906 (1)</b>
On-Off-On Function	<b>85919 (1)</b>
On-On Function	<b>85959 (1)</b>



**86930 (1)**

**Lever Wedge - Plastic**

15 Amps (180 watts). Use with .250" disconnect terminals. Drill 7/16" hole for easy installation.

On-Off-On Function	<b>86930 (1)</b>
--------------------	------------------

Visit us at [www.motormite.com](http://www.motormite.com)

## Electrical - Switches - Toggle (continued)

**85982 (1)**



**Metal Bat Pre-Wired**

Includes On-Off face plate and has 5' leads. Drill 1/2" hole or use with panel 85925.

10 Amp (120 watts) On-Off **85982 (1)**

**85900 (1)**



**Metal Bat Right Angle Mount**

On-Off function. Screw terminals. Drill 1/2" hole or use panel 85925.

15 Amp (180 watts) **85900 (1)**

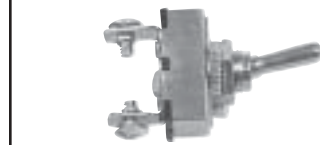

**Metal Bat w/Screw Terminals**

Includes On-Off face plate. Drill 1/2" hole or use with panel 85925.

6 Amp (72 watts) Brass Terminals On-Off **85903 (1)**

10 Amp (120 watts) Brass Terminals On-Off-On **85907 (1)**

10 Amp (120 watts) On-Off-On **85905 (1)**

15 Amp (180 watts) Brass Terminals On-Off **85908 (1)**

20 Amp (240 watts) Brass On-Off **85902 (1)**

20 Amp (240 watts) On-Off **85901 (1)**

**85943 (1)**

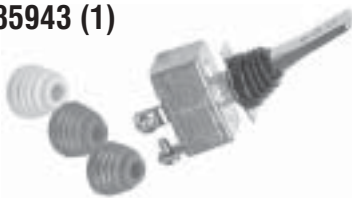

**Waterproof w/Screw Terminals**

35 Amp (420 watts). Includes 4 color interchangeable waterproof boots. On-Off function. Drill 1/2" hole for installation.

**85943 (1)**



Do you know which switch to buy for your project? See the chart on page 66 for details.



Pulse FX™ now offers race car inspired red, blue and yellow colored switches, see pages 90-91.

## Electrical - Terminals - Batteries

**Conduct-Tite!**

**84397 (1)**



**Battery Terminal Bolt**

Truck Side Post Battery Bolt.

**84398 (1)**



**Battery Terminal Bolt Extender**

Top Post Battery Bolt Extender. Replace original nut with extender to provide a place for wiring accessories.

**84399 (1)**



**Battery Terminal Bolt Extender**

Side Post Battery Bolt Extender. Replace original bolt with extender to provide a place for wiring accessories.

**85641 (2)**



**Anti-Corrosion Washers**

No-corrode washers. For top and side post batteries.

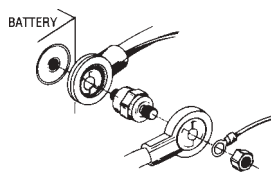

84397

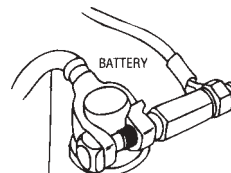

84398

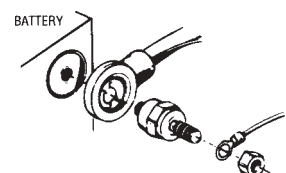

84399

**NEW PRODUCT HOTLINE - 1-800-336-3575**

**E**