

Oil Cooler Line Assemblies

82 SKUs



Dorman® OE Solutions™ Oil Cooler Line Assemblies are made from premium CSM rubber.

- Direct OE Replacement
- Coverage For the Most Failure-Prone Lines
- 2WD and 4WD coverage available



625-100
GM K & V-Series

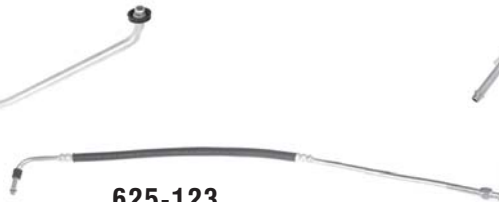

625-123
GM K & V-Series



625-129
GM G-Series Vans

Dorman® OE Solutions™ Oil Cooler Line Assemblies Feature:

- Includes everything needed to install:
O-rings, Gaskets and Connector Retaining Clips (where applicable).

Prevent Breakdown

- Over time, leaks develop at Oil Cooler Line Hose crimps
- Leaking crimps can completely separate causing **Severe Engine Damage**
- Replace defective Quick Connector fittings
- New Quick Connectors/Clips Included (where required)
- Replacing both Oil Cooler Lines at the same time is recommended



See pages 327-362 for Quick Disconnect quick connectors.

Other Dorman Fluid Lines Available:

| | | | |
|--------------------|----------------------|---------------------|----------------------|
| Clutch | <i>pages 257-260</i> | Fuel | <i>pages 149-154</i> |
| Heater Hose | <i>pages 255-256</i> | Transmission | <i>pages 485-532</i> |

Activant Path

*Pistons/Oil Pump
and Block Parts*

Activant Code

DOL

**Applications begin
on page 293.**

Oil Cooler Line Assemblies

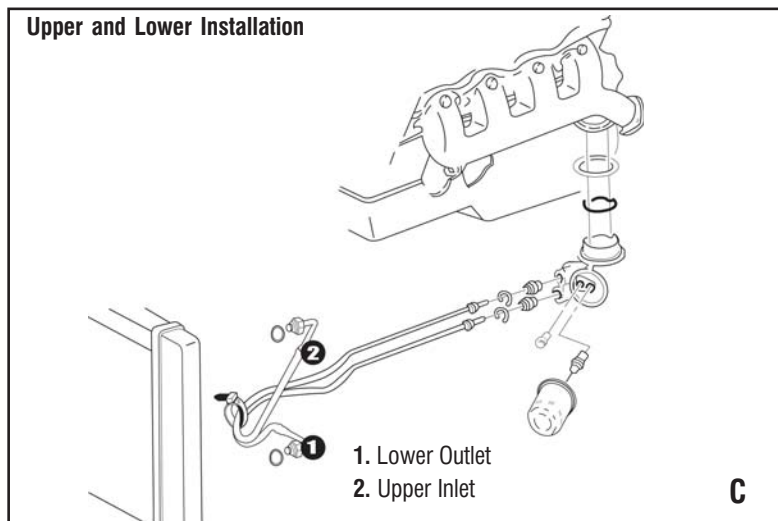
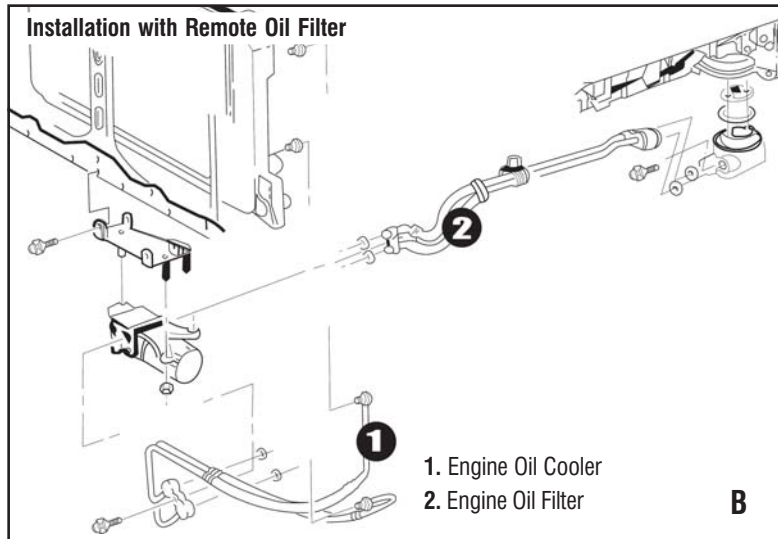
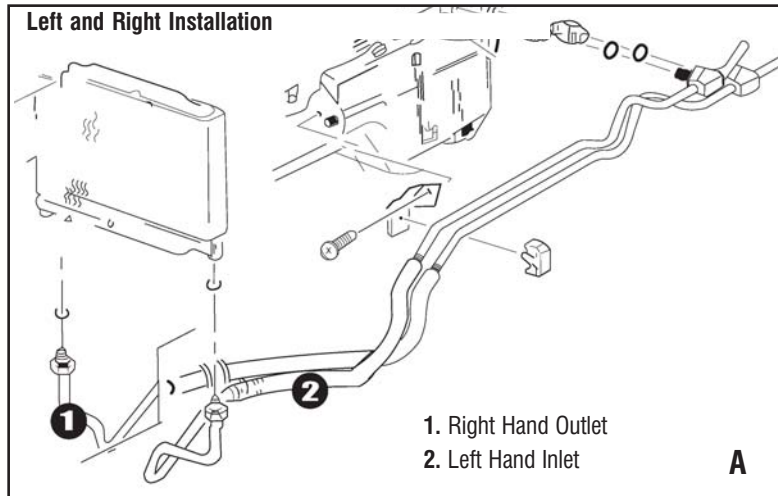

Oil Cooler Line Assemblies

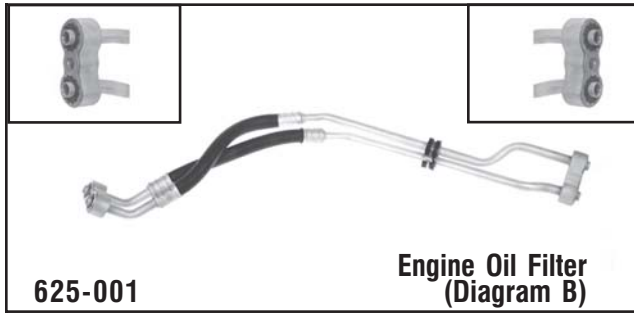

625-001

**Engine Oil Filter
(Diagram B)**

GM
2005-96 S10 Blazer, S15 Jimmy, S15 Sonoma, Bravada w/4.3L V-6 4WD Engine Oil Filter Hose.

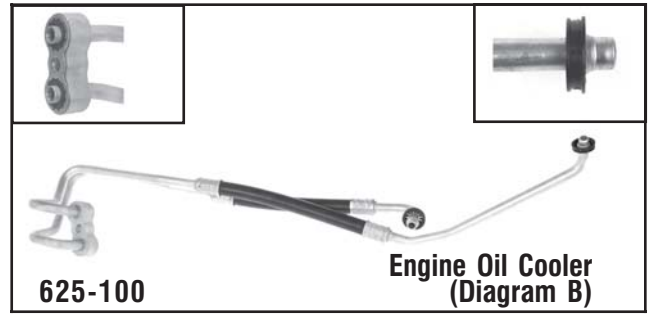

625-100

**Engine Oil Cooler
(Diagram B)**

GM
2002-96 S10 Blazer, S15 Jimmy, S15 Sonoma, Bravada w/4.3L V-6 4WD Eng Oil Cooler Pipe.

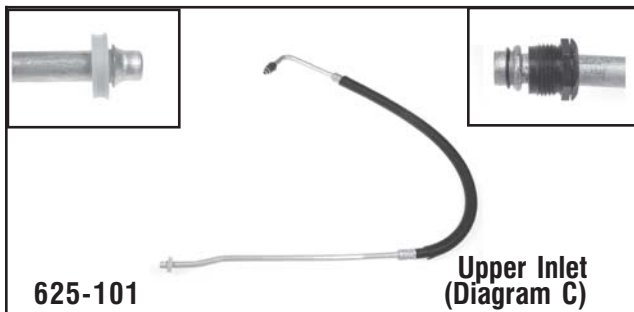

625-101

**Upper Inlet
(Diagram C)**

GM
1999 Escalade, 1999-96 K Series w/5.0L, 2000-96 K-Series w/5.7L, 1999-96 Suburban w/5.7L, 2000-96 Tahoe, Yukon w/5.7L, 4WD Eng Oil Cooler Upper-Inlet Hose.

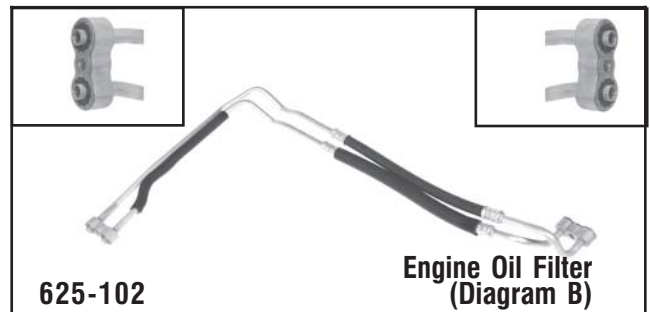

625-102

**Engine Oil Filter
(Diagram B)**

GM
1994-88 S10 Blazer, S15 Jimmy, 1990-88 S15 Pickups, 1993-91 S15 Sonoma, 1991 S15 Syclone, 1993-92 Typhoon, 1994-91 Bravada w/4.3L V-6 4WD Engine Oil Filter Hose.

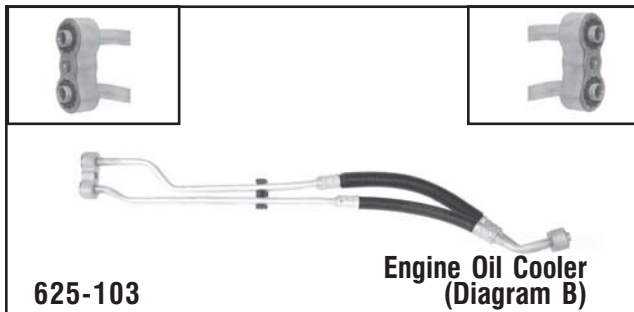

625-103

**Engine Oil Cooler
(Diagram B)**

GM
1995-94 S10 Blazer, S15 Sonoma, 1995 S15 Jimmy w/4WD Eng Oil Filter Hose

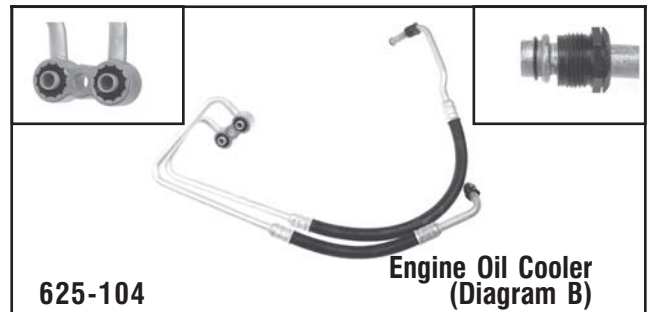

625-104

**Engine Oil Cooler
(Diagram B)**

GM
1995-94 S10 Blazer, S10 Pickups, S15 Jimmy, S15 Sonoma w/4.3L V-6 4WD Eng Oil Cooler Hose.

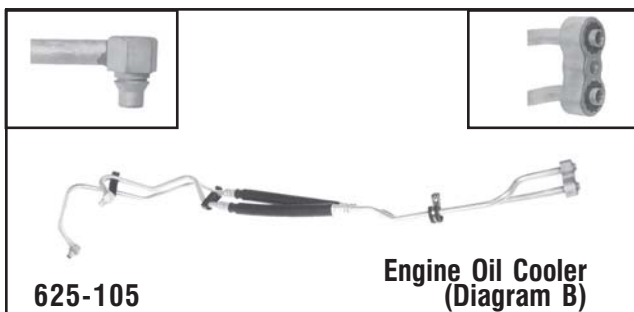

625-105

**Engine Oil Cooler
(Diagram B)**

GM
2005-96 Astro, Safari Vans w/4.3L V-6 Eng Oil Cooler Hose.

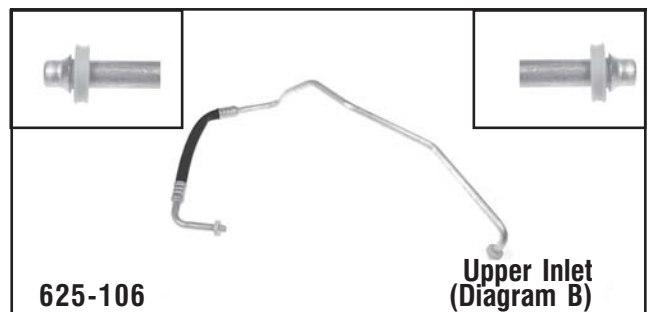

625-106

**Upper Inlet
(Diagram B)**

GM
2002-96 Express & Savana Vans, 1996 G-Series Vans w/6.5L Auxiliary Eng Oil Cooler Upper Inlet Hose.

Oil Cooler Line Assemblies

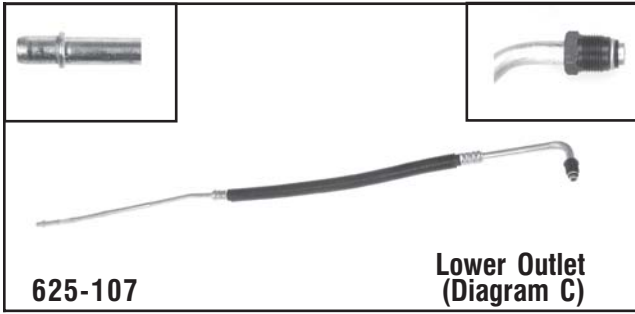

625-107

**Lower Outlet
(Diagram C)**

GM
1994 Blazer, 1995-94 K-Series, Suburban, Yukon, 1995 Tahoe w/
3.42R, 3.73R, 4.10R, 4.56R Eng Oil Cooler Lower Outlet Hose.

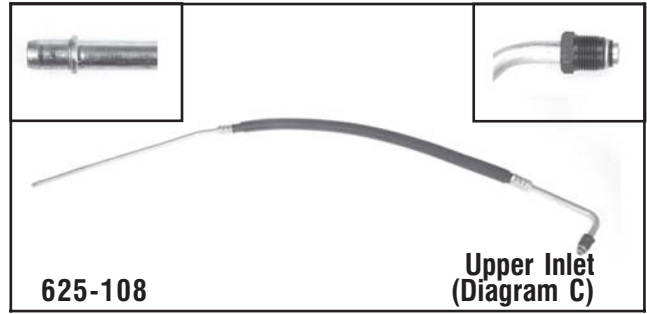

625-108

**Upper Inlet
(Diagram C)**

GM
1994 Blazer, 1995-94 K-Series, Suburban, Yukon, 1995 Tahoe, w/
5.7L 4WD 3.42R, 3.73R, 4.10R, 4.56R Eng Oil Cooler Upper Inlet
Hose.

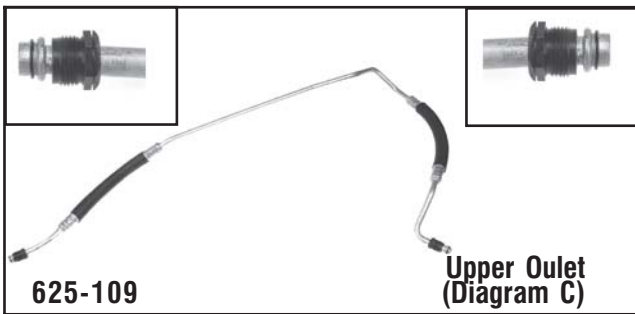

625-109

**Upper Outlet
(Diagram C)**

GM
1996-94 G-Series Vans w/6.5L Eng Oil Cooler Upper Outlet Pipe.

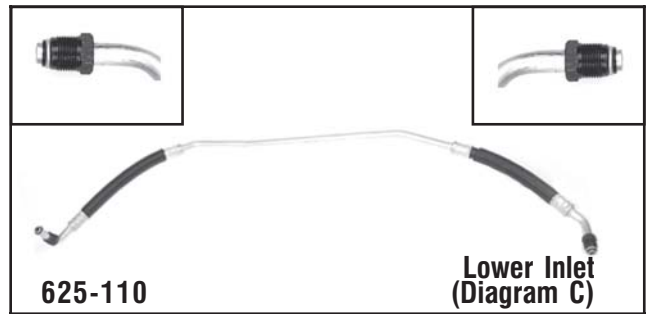

625-110

**Lower Inlet
(Diagram C)**

GM
1996-94 G-Series Vans w/6.5L Eng Oil Cooler Lower Inlet Pipe.

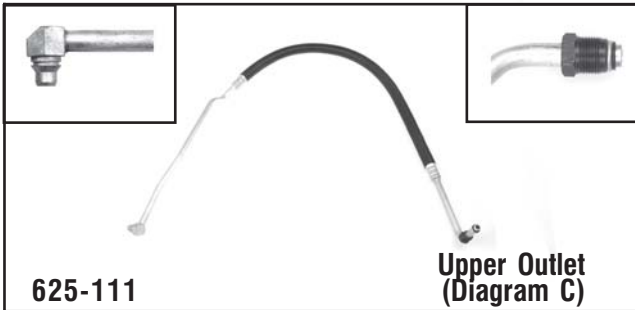

625-111

**Upper Outlet
(Diagram C)**

GM
1995-94 C&K Series, Suburban w/7.5L Eng Oil Cooler Upper
Outlet Hose w/o HD Cooling.

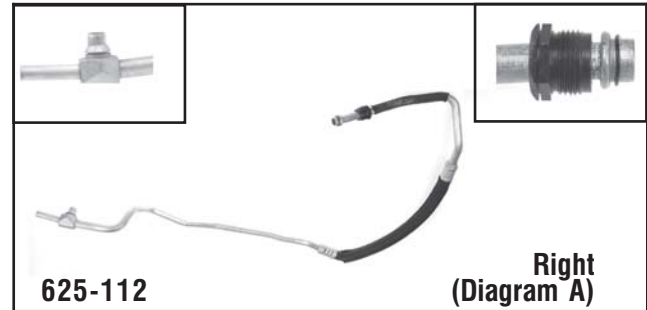

625-112

**Right
(Diagram A)**

GM
2002-98 C-Series Pickups w/6.5L, 1997 1 Ton w/Connecting Nut
27.0mm Across Flats. Eng Oil Cooler. RH Side. Outlet Hose.

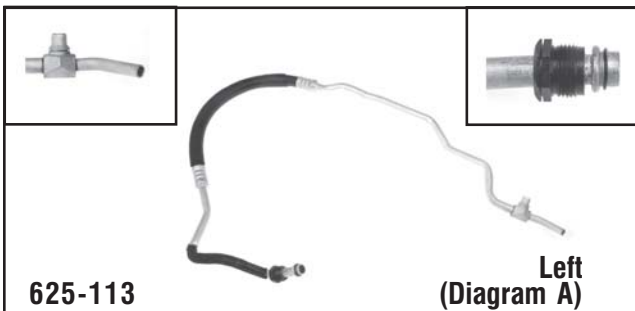

625-113

**Left
(Diagram A)**

GM
2002-98 C-Series, 1997 1 Ton Connecting Nut 27.0mm Across
Flats. w/6.5L Eng Oil Cooler. LH Side. Inlet Hose.

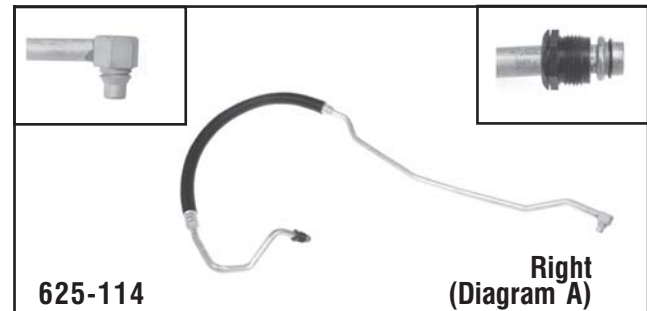

625-114

**Right
(Diagram A)**

GM
1997-95 C&K Series Pickups 1/2 & 3/4 Ton, Suburban, Tahoe,
Yukon, 1997 C&K Series Pickups 1 Ton w/Connecting Nuts
.75mm Across Flats; Exc. 15,000 GVWR, 1996-95 C&K Series
Pickups 1 Ton; Exc. 15,000 GVWR w/6.5L Eng Oil Cooler RH
Side. Outlet Hose.

Oil Cooler Line Assemblies

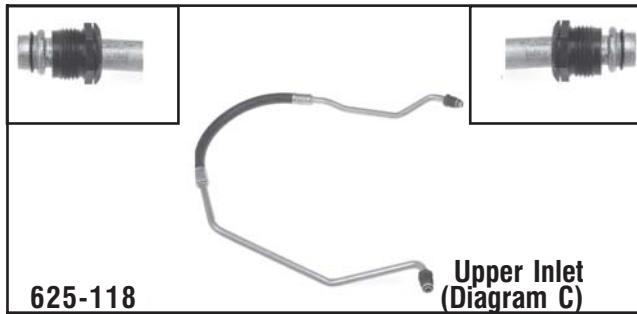

625-118

**Upper Inlet
(Diagram C)**

GM
1993-85 Astro and Safari 2WD, Upper Inlet

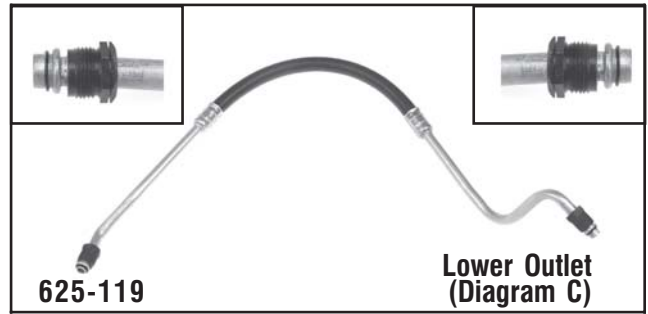

625-119

**Lower Outlet
(Diagram C)**

GM
1993-85 Astro/ Safari 2WD, Lower Outlet

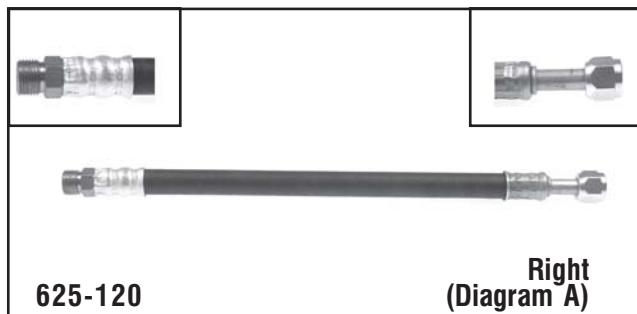

625-120

**Right
(Diagram A)**

GM
1991-85 G-Series Vans 5.0L, 5.7L, Side Inlet

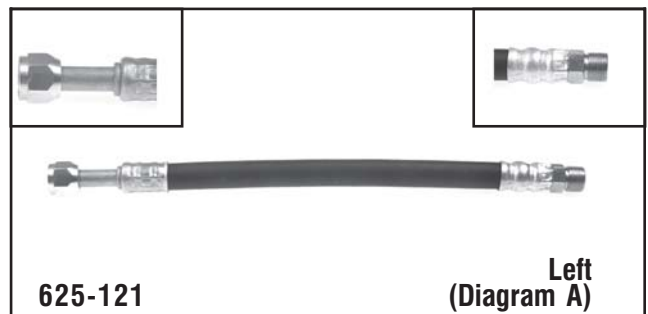

625-121

**Left
(Diagram A)**

GM
1991-85 G-Series Vans 5.0L, 5.7L, Side Outlet

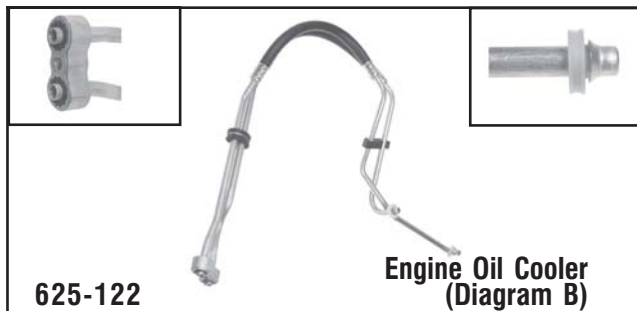

625-122

**Engine Oil Cooler
(Diagram B)**

GM
2005-96 Blazer, S15 Jimmy S10 Pickup, S15 Sonoma 2WD

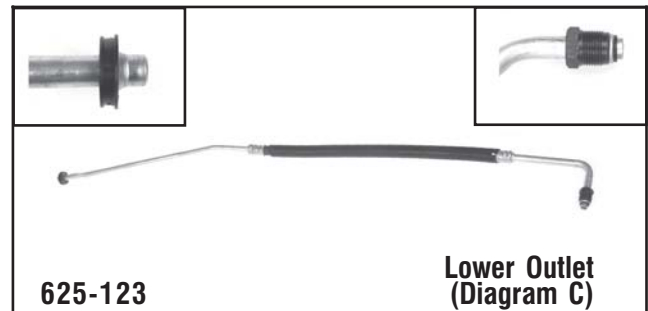

625-123

**Lower Outlet
(Diagram C)**

GM
2000-96 K-Series Pickups, Tahoe and Yukon 4WD, 1999-96 Suburban 4WD Lower Outlet

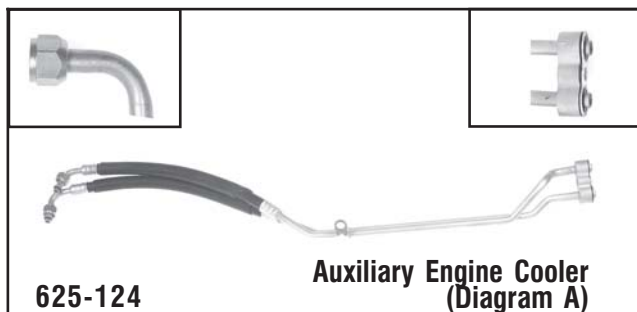

625-124

**Auxiliary Engine Cooler
(Diagram A)**

GM
1996-94 Caprice Police Package

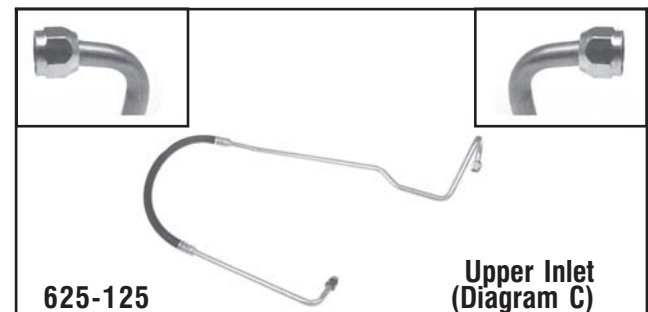

625-125

**Upper Inlet
(Diagram C)**

GM
1991-85 G-Series Vans w/6.2L Diesel, Upper Inlet

Oil Cooler Line Assemblies

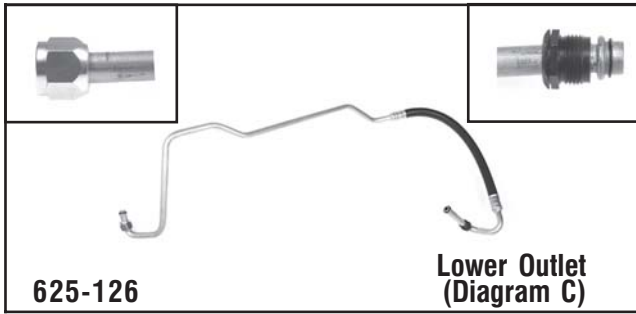

625-126

**Lower Outlet
(Diagram C)**

GM
1991-85 G-Series Vans w/6.2L Diesel, Lower Outlet

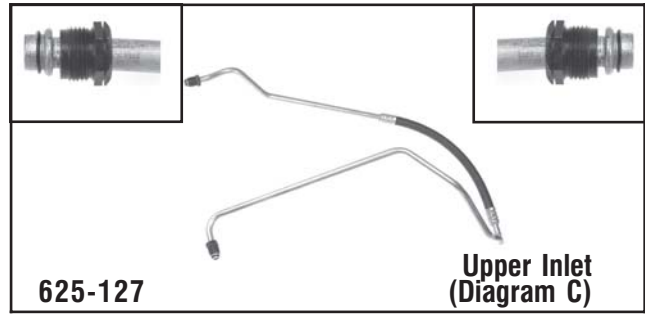

625-127

**Upper Inlet
(Diagram C)**

GM
1995 S 10 Blazer, 1995-94 S10 Pickups, 1995 S15 Jimmy, 1995-94 S15 Sonoma 2WD, Upper Inlet

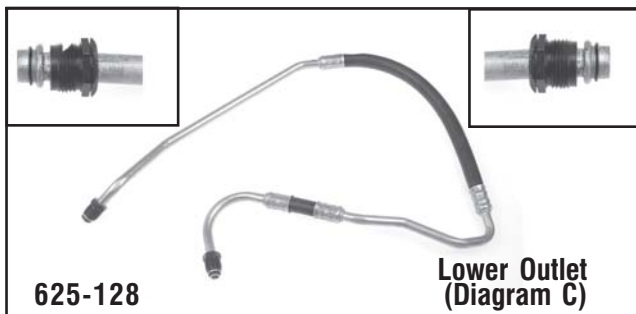

625-128

**Lower Outlet
(Diagram C)**

GM
1995 S 10 Blazer, 1995-94 S10 Pickups, 1995 S15 Jimmy, 1995-94 S15 Sonoma 2WD, Lower Outlet

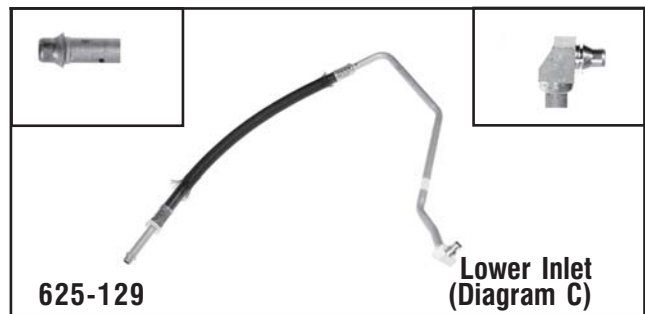

625-129

**Lower Inlet
(Diagram C)**

GM
2002-96 Express, Savana Vans, 1996 G-Series Vans w/ 6.5L V-8 Diesel, Eng Oil Cooler Lower Inlet Hose

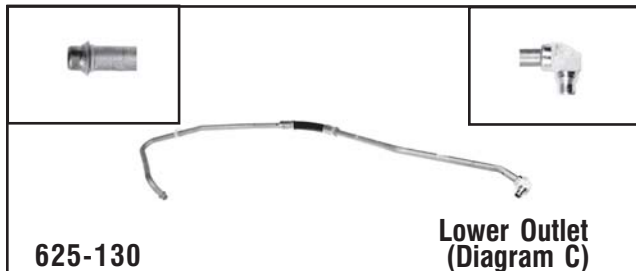

625-130

**Lower Outlet
(Diagram C)**

GM
2002-96 Express, Savana Vans, 1996 G-Series Vans w/ 6.5L V-8 Diesel, Auxiliary Eng Oil Cooler Lower Outlet Hose

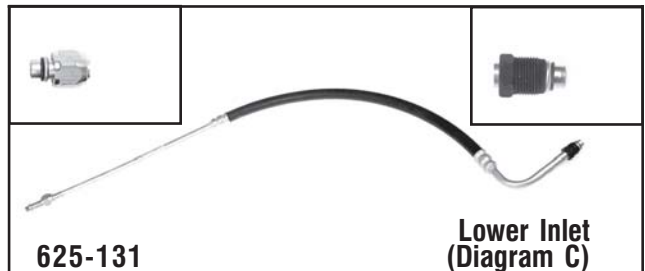

625-131

**Lower Inlet
(Diagram C)**

GM
1991-87 V-Series Pickups w/ 5.0L, 5.7L, 7.4L, 1991-85 Blazer, Jimmy, Suburban w/ 5.0L, 5.7L, 7.4L 4WD, 1986-85 K Series w/ 5.0L, 5.7L, 7.4L Eng Oil Cooler Lower Inlet Hose

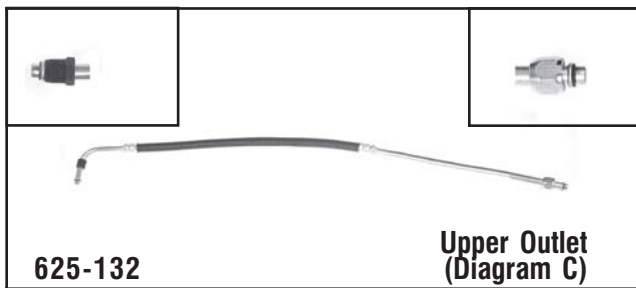

625-132

**Upper Outlet
(Diagram C)**

GM
1991-87 V-Series Pickups w/ 5.0L, 5.7L, 7.4L, 1991-85 Blazer, Jimmy, Suburban w/ 5.0L, 5.7L, 7.4L 4WD, 1986-85 K-Series w/ 5.0L, 5.7L, 7.4L Eng Oil Cooler Upper Outlet Hose

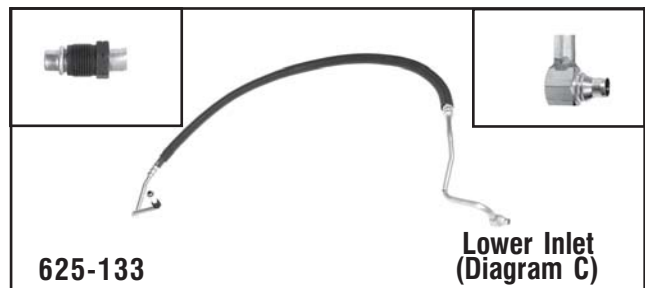

625-133

**Lower Inlet
(Diagram C)**

GM
1992 C&K-Series Pickups, Suburban w/ 6.2L HD Cooling wo/ Hose Protector, 1991-88 C&K-Series Pickups w/ 6.2L HD Cooling Eng Oil Cooler Lower Inlet Hose

Oil Cooler Line Assemblies

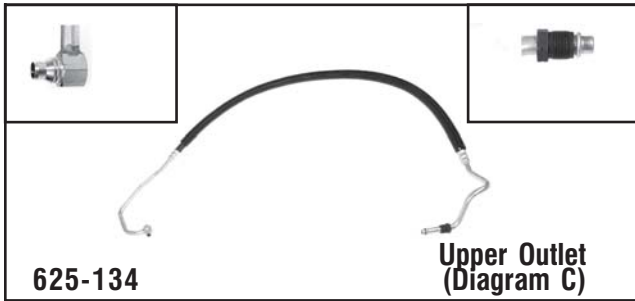

625-134

**Upper Outlet
(Diagram C)**

GM
1994-92 C&K Series Pickups, Suburban Under 12,000 GVW, 1994 Blazer, Yukon w/ 6.5L Diesel, 1993-88 C&K-Series Pickups, w/ 6.2L Diesel w/HD Cooling Eng Oil Cooler Upper Outlet Hose

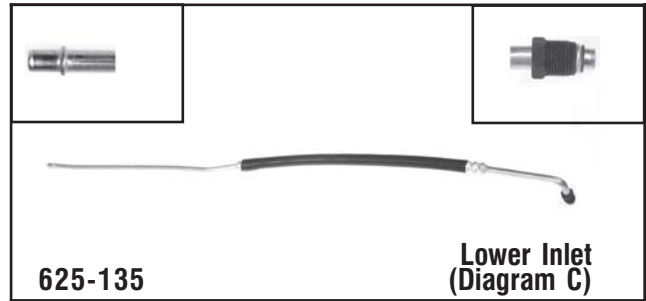

625-135

**Lower Inlet
(Diagram C)**

GM
1995-94 C-Series Pickups 1/2 & 3/4 Ton, Suburban 2WD, Yukon 2WD, 1995 C-Series Pickups 1 Ton, Tahoe 2WD, 1994 Blazer 2WD w/ 5.7L Eng Oil Cooler Lower Inlet Hose

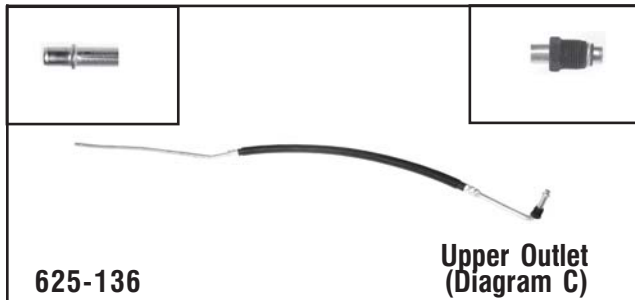

625-136

**Upper Outlet
(Diagram C)**

GM
1995-94 C-Series Pickups 1/2 & 3/4 Ton, Suburban 2WD, Yukon 2WD, 1995 C-Series Pickups 1 Ton, Tahoe 2WD, 1994 Blazer 2WD w/ 5.7L Eng Oil Cooler Upper Outlet Hose

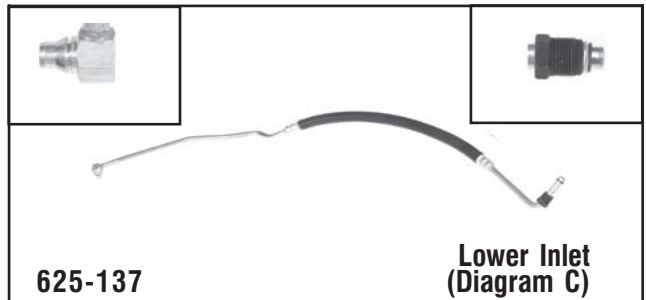

625-137

**Lower Inlet
(Diagram C)**

GM
1995-94 C&K-Series Pickups, Suburban w/ 7.4Lwo/HD Cooling Eng Oil Cooler Lower Inlet Hose

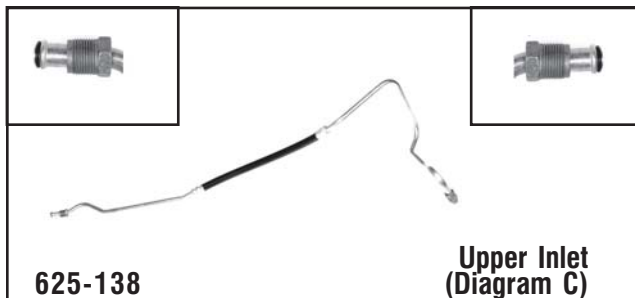

625-138

**Upper Inlet
(Diagram C)**

GM
1995 Astro, Safari Van w/ 4.3L Eng Oil Cooler Upper Inlet Hose

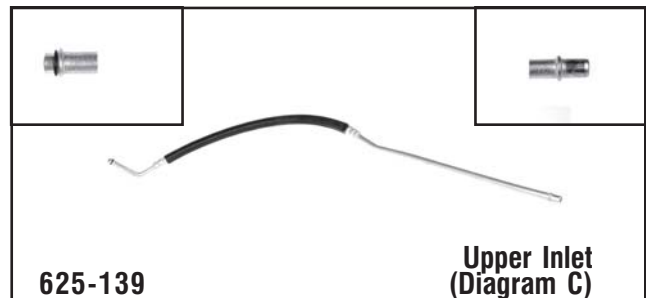

625-139

**Upper Inlet
(Diagram C)**

GM
1995-88 C-Series Pickups w/ 5.0L, 1993-92 Blazer, Suburban, Yukon w/ 5.7L 2WD, 1993-88 C-Series Pickups w/ 5.7L, Eng Oil Cooler Upper Inlet Hose

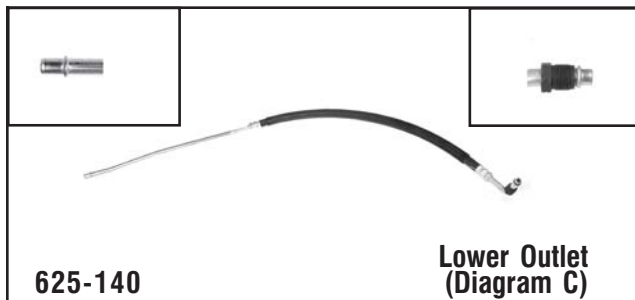

625-140

**Lower Outlet
(Diagram C)**

GM
1995-88 C-Series Pickups w/ 5.0L, 1993-92 Blazer, Suburban, Yukon w/ 5.7L 2WD, 1993-88 C-Series Pickups w/ 5.7L, Eng Oil Cooler Lower Outlet Hose

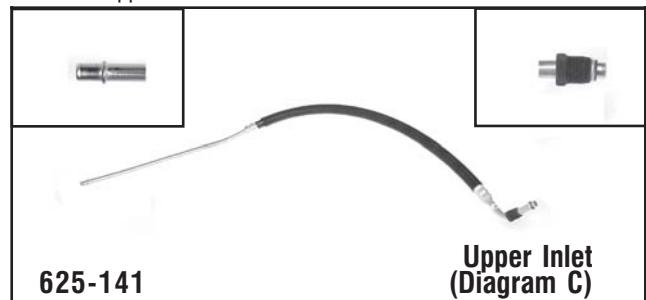

625-141

**Upper Inlet
(Diagram C)**

GM
1995-88 K-Series Pickups w/ 5.0L, 1993-92 Blazer, Suburban, Yukon w/ 5.7L 4WD, 1993-88 K-Series Pickups w/ 5.7L Eng Oil Cooler Upper Inlet Hose

Oil Cooler Line Assemblies

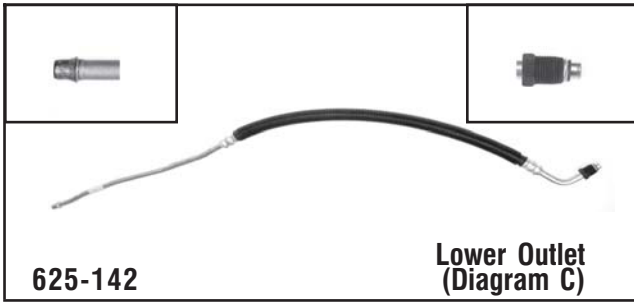

625-142

**Lower Outlet
(Diagram C)**

GM
1995-88 K-Series Pickups w/ 5.0L, 1993-92 Blazer, Suburban, Yukon w/ 5.7L 4WD, 1993-88 K-Series Pickups w/ 5.7L Eng Oil Cooler Lower Outlet Hose

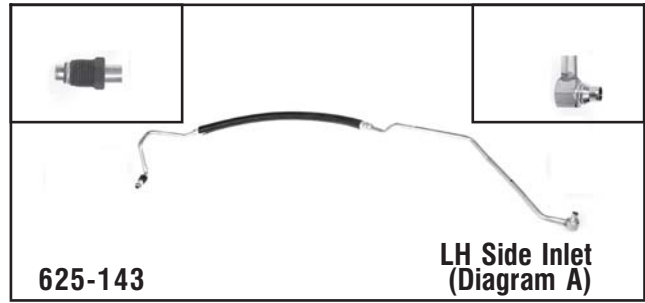

625-143

**LH Side Inlet
(Diagram A)**

GM
1997-95 C&K-Series Pickups Exc. 15,000 GVW, Suburban, Tahoe, Yukon w/ 6.5L Diesel, Connecting Nut .875" Across Flats, Eng Oil Cooler LH Side Inlet Hose

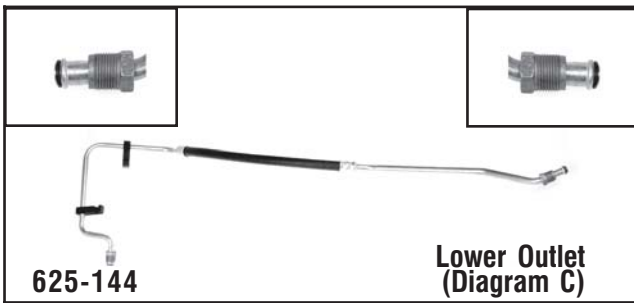

625-144

**Lower Outlet
(Diagram C)**

GM
1995 Astro, Safari w/ 4.3L Eng Oil Cooler Lower Outlet Hose

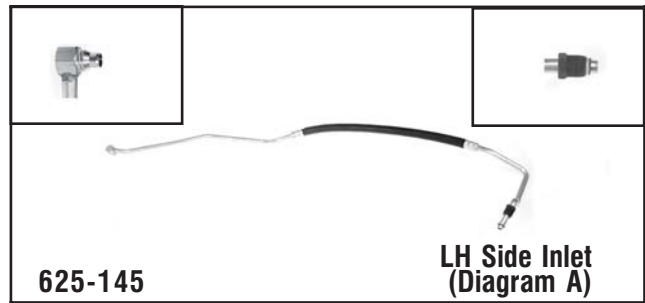

625-145

**LH Side Inlet
(Diagram A)**

GM
1997-95 C-Series Pickups 1 Ton 15,000 GVW w/ 6.5L Diesel Connecting Nut 25.4mm Across Flats, Eng Oil Cooler LH Side Inlet Hose

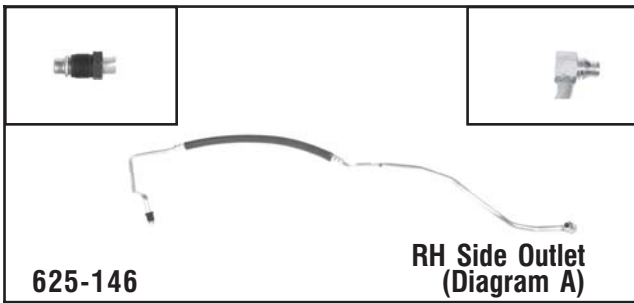

625-146

**RH Side Outlet
(Diagram A)**

GM
1997-95 C-Series Pickups 1 Ton 15,000 GVW w/ 6.5L Diesel Connecting Nut 25.4mm Across Flats, Eng Oil Cooler RH Side Outlet Hose

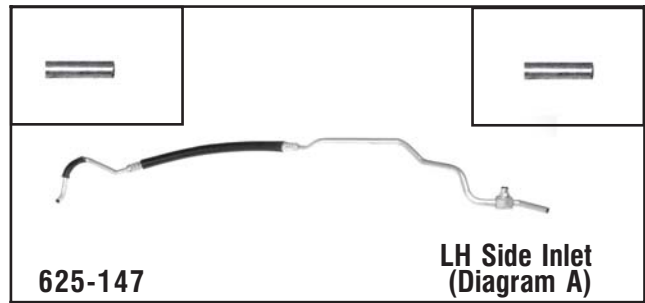

625-147

**LH Side Inlet
(Diagram A)**

GM
2000-97 C&K-Series Pickups, Suburban, Tahoe, Yukon w/ 6.5L Diesel Connecting Nut 27mm Across Flats, Eng Oil Cooler LH Side Inlet Hose

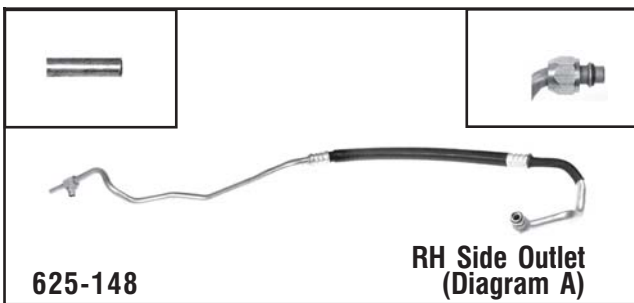

625-148

**RH Side Outlet
(Diagram A)**

GM
2000-97 C&K-Series Pickups, Suburban, Tahoe, Yukon w/ 6.5L Diesel Connecting Nut 27mm Across Flats, Eng Oil Cooler RH Side Outlet Hose

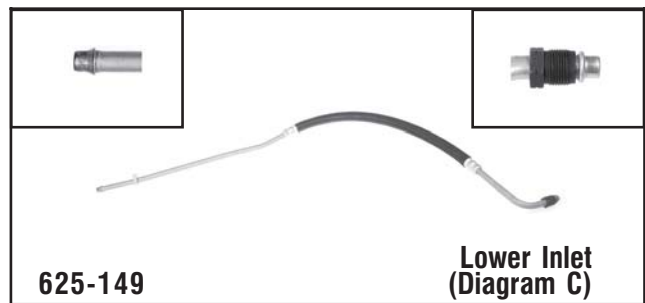

625-149

**Lower Inlet
(Diagram C)**

GM
2000-96 C-Series Pickups, Tahoe 2WD, Yukon 2WD w/ 5.7L, 1999-96 C-Series Pickups w/140 Amp Alternator w/ 5.0L, Suburban 2WD w/ 5.7L Eng Oil Cooler Lower Inlet Hose

Oil Cooler Line Assemblies

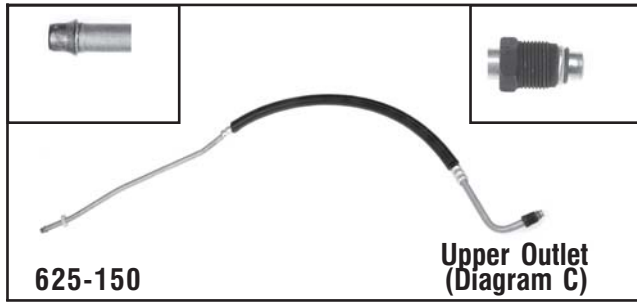

625-150 Upper Outlet (Diagram C)

GM
2000-96 C-Series Pickups, Tahoe 2WD, Yukon 2WD w/ 5.7L, 1999-96 C-Series Pickups w/140 Amp Alternator w/ 5.0L, Suburban 2WD w/ 5.7L Eng Oil Cooler Upper Outlet Hose

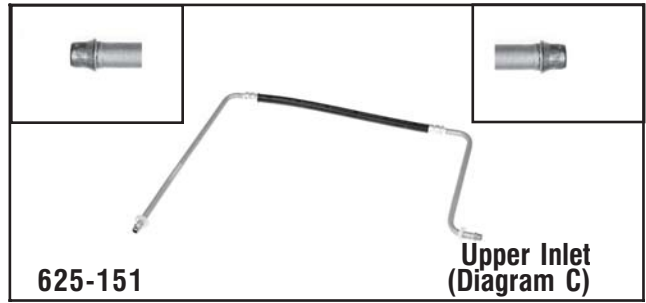

625-151 Upper Inlet (Diagram C)

GM
2002-96 Express Savana Vans, 1996 G-Series Vans Eng Vin R w/ 5.7L Eng Oil Cooler Upper Inlet Hose

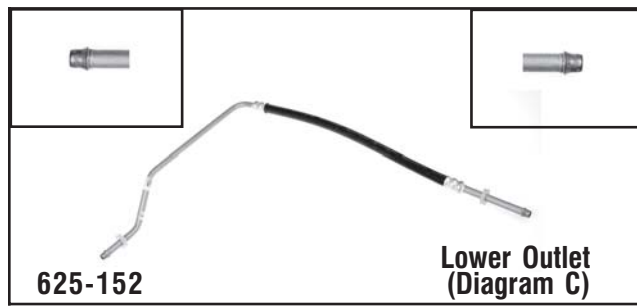

625-152 Lower Outlet (Diagram C)

GM
2002-96 Express Savana Vans, 1996 G-Series Vans Eng Vin R w/ 5.7L Eng Oil Cooler Lower Outlet Hose

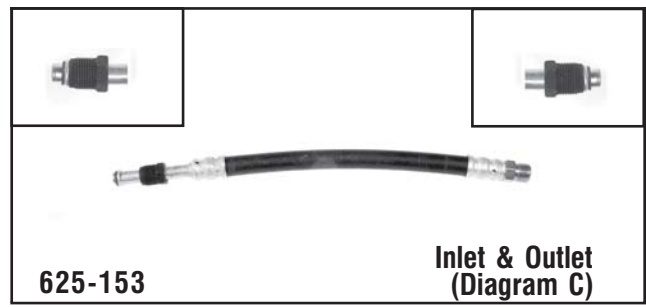

625-153 Inlet & Outlet (Diagram C)

GM
1996 G-Series Vans w/ 5.7L Vin K, 1995-92 G-Series Vans w/ 5.0L, 5.7L Eng Oil Cooler Inlet and Outlet Hose

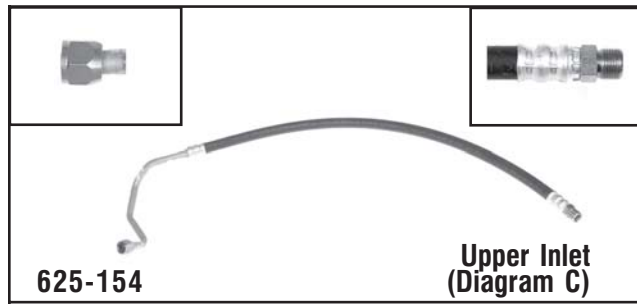

625-154 Upper Inlet (Diagram C)

GM
1991-85 Suburban, 1991-87 R & V-Series Pickups, 1991-85 Jimmy, Blazer, 1986-85 C&K Series Pickups w/ 6.2L Diesel Eng Oil Cooler Upper Inlet Hose

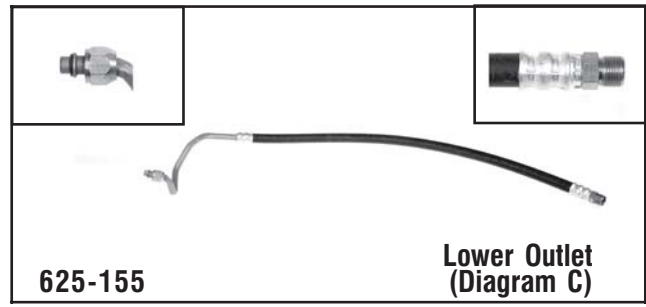

625-155 Lower Outlet (Diagram C)

GM
1991-85 Suburban, 1991-87 R & V-Series Pickups, 1986-85 C&K Series Pickup w/ 6.2L Diesel Eng Oil Cooler Lower Outlet Hose

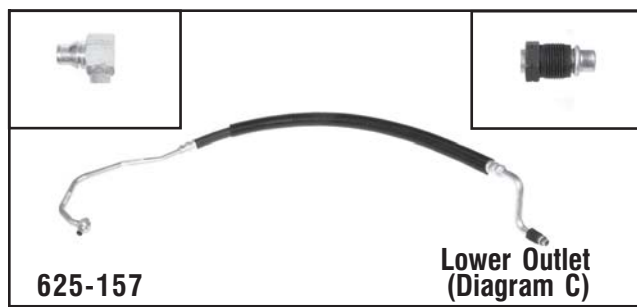

625-157 Lower Outlet (Diagram C)

GM
1993-88 C&K-Series Pickups, 1993-92 Suburban w/ 6.2L Diesel wo/ HD Cooling, 1993-92 C-Series Pickups 15,000 GVW & Over w/ 6.5L Diesel Eng Oil Cooler Lower Outlet Hose

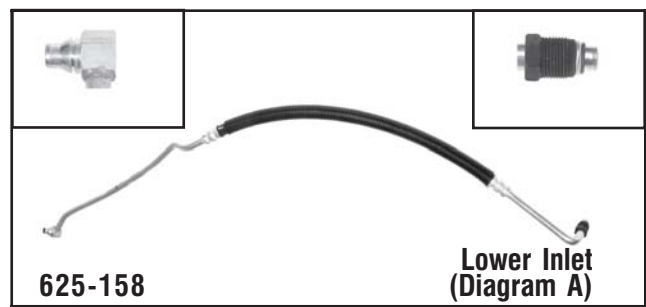

625-158 Lower Inlet (Diagram A)

GM
1993-92 C-Series Pickups, Suburban w/ 7.4L wo/ HD Cooling Oil Cooler Lower Inlet Hose

Oil Cooler Line Assemblies

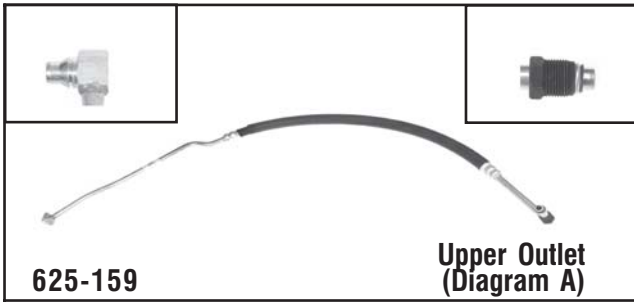

625-159

**Upper Outlet
(Diagram A)**

GM
1993-92 C-Series Pickups, Suburban w/ 7.4L wo/ HD Cooling Oil Cooler Upper Outlet Hose

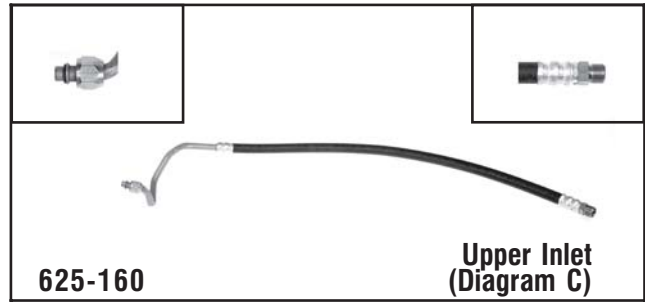

625-160

**Upper Inlet
(Diagram C)**

GM
1993-92 Blazer, Suburban, Yukon 2WD, 1993-88 C-Series Pickups w/ 5.7L Eng Oil Cooler Upper Inlet Hose

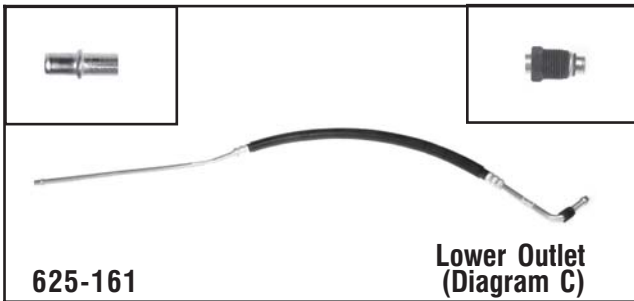

625-161

**Lower Outlet
(Diagram C)**

GM
1993-92 Blazer, Suburban, Yukon 2WD, 1993-88 C-Series Pickups w/ 5.7L Eng Oil Cooler Lower Outlet Hose

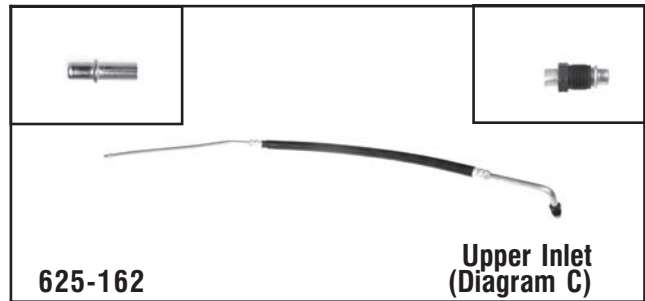

625-162

**Upper Inlet
(Diagram C)**

GM
1993-92 Blazer, Suburban, Yukon 4WD, 1993-91 K-Series w/ 5.7L 4.10R, 4.56R Eng Oil Cooler Upper Inlet Hose

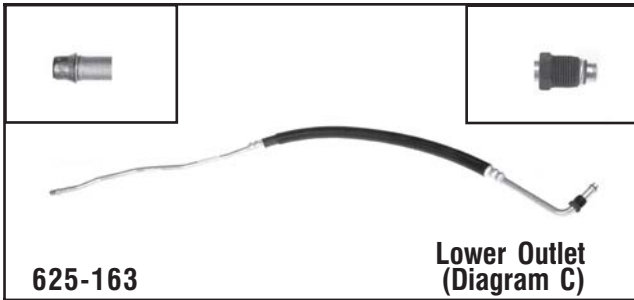

625-163

**Lower Outlet
(Diagram C)**

GM
1993-92 Blazer, Suburban, Yukon 4WD, 1993-91 K-Series w/ 5.7L 4.10R, 4.56R Eng Oil Cooler Lower Outlet Hose

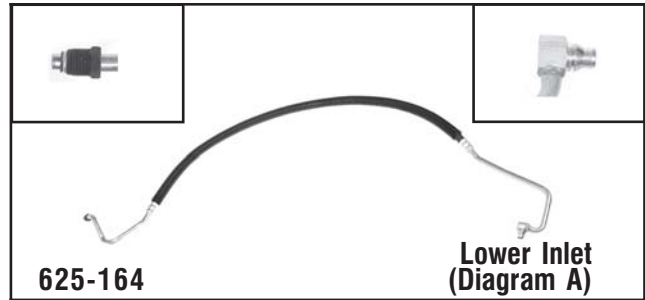

625-164

**Lower Inlet
(Diagram A)**

GM
1994-92 C&K-Series Pickups, Suburban w/ 6.5L Diesel under 12,000 GVW, 1994 Yukon, 1993-92 C&K-Series Pickups, Suburban w/ HD Cooling, w/ 6.2L Diesel Eng Oil Cooler Lower Inlet Hose

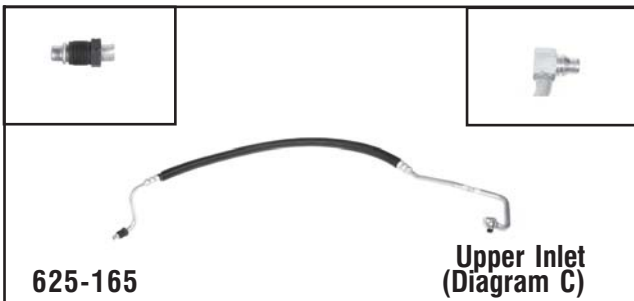

625-165

**Upper Inlet
(Diagram C)**

GM
1993-92 Suburban, 1993-88 C&K-Series Pickups w/ 6.2L Diesel wo/ HD Cooling Eng Oil Cooler Upper Inlet Hose

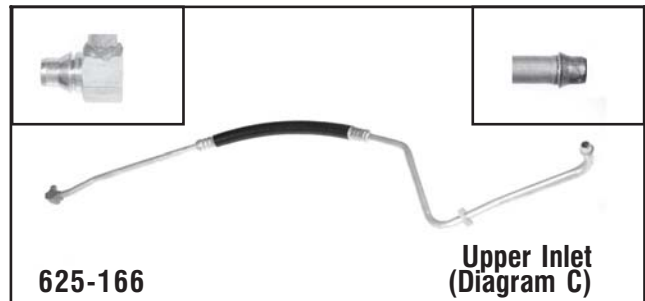

625-166

**Upper Inlet
(Diagram C)**

GM
2003-01 C-Series Pickups w/ 8.1L Eng Oil Cooler Upper Inlet Hose

Oil Cooler Line Assemblies

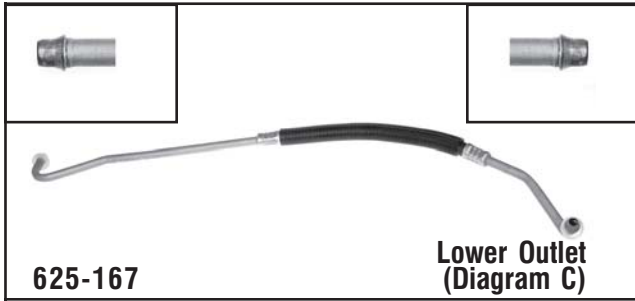

625-167

**Lower Outlet
(Diagram C)**

GM
2003-01 C-Series Pickups w/ 8.1L Eng Oil Cooler Lower Outlet Hose

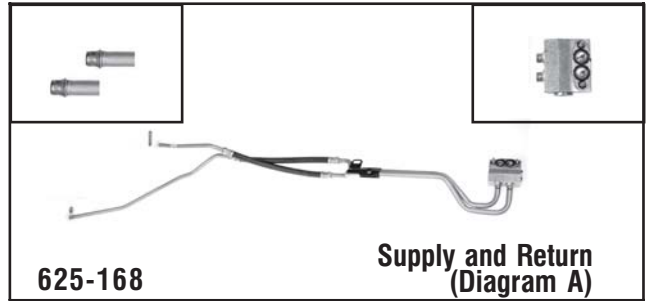

625-168

**Supply and Return
(Diagram A)**

GM
2004-99 Sierra, Silverado, 2004-03 Express, Savana Vans, 2004-02 Escalade, 2004-01 Yukon XL, 2004-00 Suburban, Yukon, 2002-01 Denali, Denali XL w/ 6.0L Eng Oil Cooler Hose

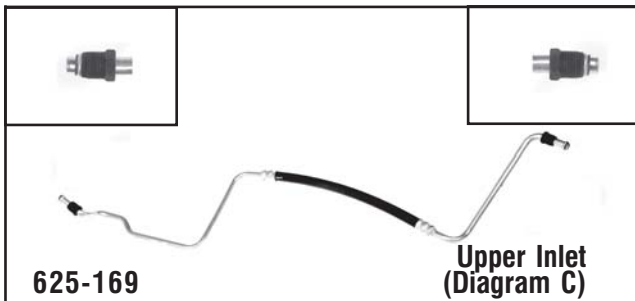

625-169

**Upper Inlet
(Diagram C)**

GM
1993-92 G-Series Vans, 1991-85 G-Series Vans Exc. A/C Manual Control w/ 4.3L Eng Oil Cooler Upper Inlet Hose

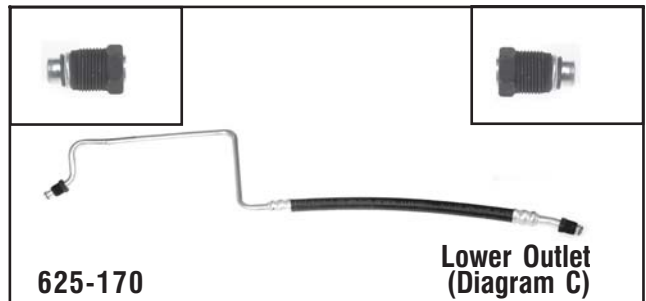

625-170

**Lower Outlet
(Diagram C)**

GM
1993-92 G-Series Vans, 1991-85 G-Series Vans Exc. A/C Manual Control w/ 4.3L Eng Oil Cooler Lower Outlet Hose

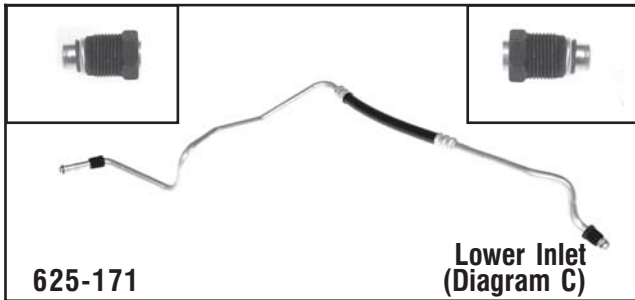

625-171

**Lower Inlet
(Diagram C)**

GM
1996-94 G-Series Vans w/ HD Cooling, 1993-92 G-Series Vans w/ A/C Manual Control w/ 4.3L Eng Oil Cooler Lower Inlet Hose

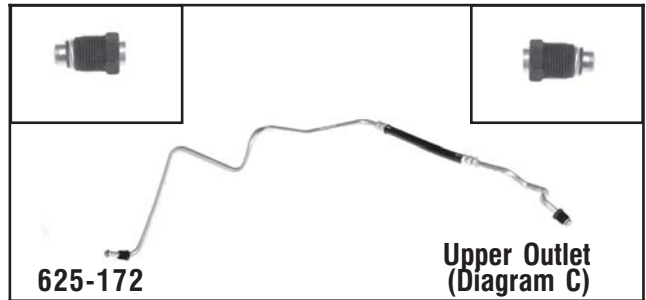

625-172

**Upper Outlet
(Diagram C)**

GM
1996-94 G-Series Vans w/ HD Cooling, 1993-92 G-Series Vans w/ A/C Manual Control w/ 4.3L Eng Oil Cooler Upper Outlet Hose

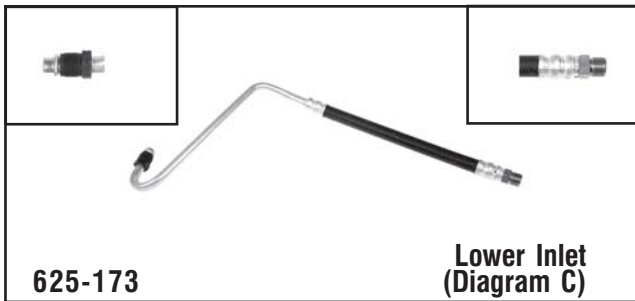

625-173

**Lower Inlet
(Diagram C)**

GM
1993-92 G-Series Vans w/ 6.2L Diesel Eng oil Cooler Lower Inlet Hose

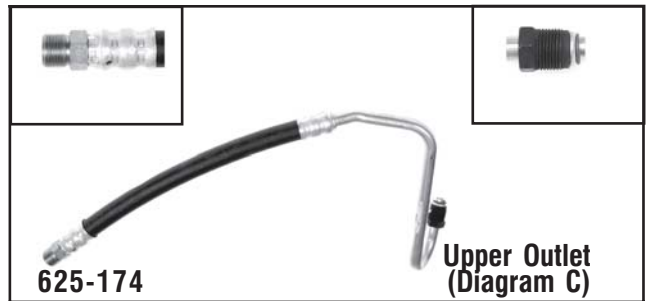

625-174

**Upper Outlet
(Diagram C)**

GM
1993-92 G-Series Vans w/ 6.2L Diesel Eng oil Cooler Upper Outlet Hose

Oil Cooler Line Assemblies

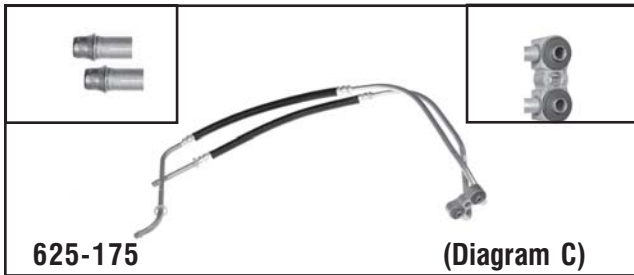

GM
2002-96 Express, Savana Vans, 1997 G-Series Van w/ 4.3L Eng Oil Cooler Hose

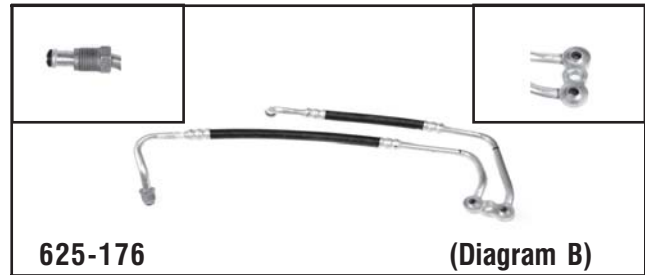

GM
1994-92 Bravada, S10 Blazer, S15 Jimmy w/ Eng VIN Z w/ HD Cooling, 1993-92 S15 Typhoon, 1991-88 S10 Blazer, S15 Jimmy w/ Eng VIN Z, 1991 Bravada Eng VIN Z, S15 Syclone, w/4.3L 4WD Eng Oil Cooler Hose

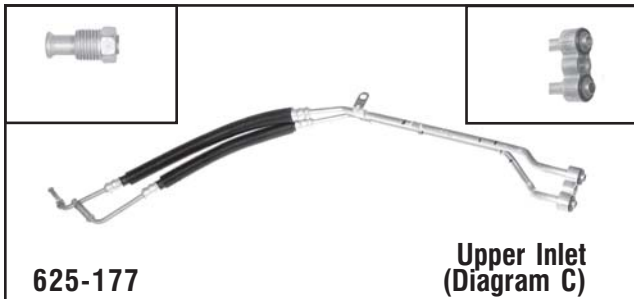

GM
1996-94 Caprice w/4.3L, Caprice Exc. Police Car, Fleetwood, Imapla SS, Roadmaster w/ 5.7L Eng Oil Cooler Upper Inlet Hose

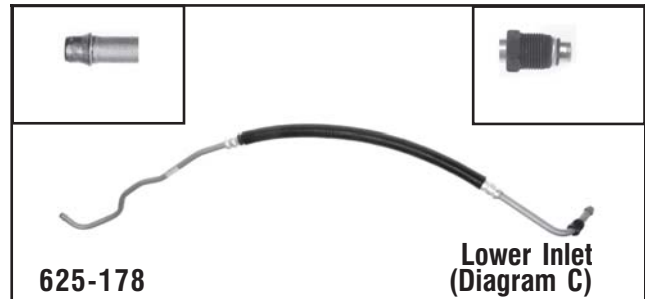

GM
2000-96 C&K-Series Pickups, 1999-96 Suburban w/ 7.4L Under 12,000 GVW Eng Oil Cooler Lower Inlet Hose

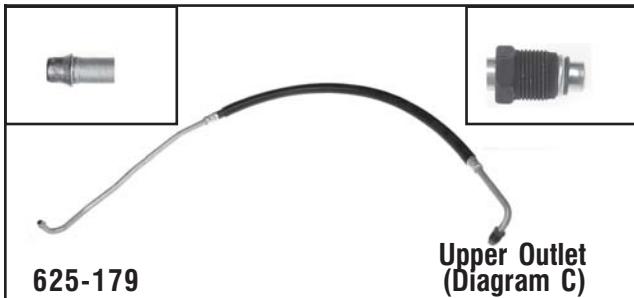

GM
2000-96 C&K-Series Pickups, 1999-96 Suburban w/ 7.4L Eng Oil Cooler Upper Outlet Hose

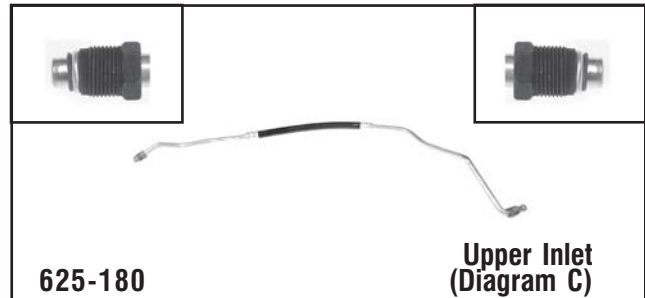

GM
1994 Astro, Safari Vans w/ 4.3L 2WD Eng Oil Cooler Upper Inlet Hose

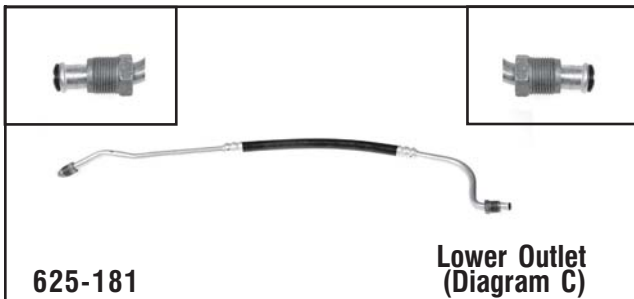

GM
1994 Astro, Safari Vans w/ 4.3L 2WD Eng Oil Cooler Lower Outlet Hose

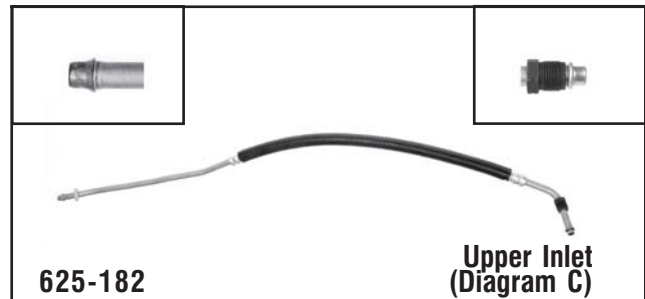

GM
1998-96 C&K-Series Pickups w/ 4.3L Engine Oil Cooler Upper Inlet Hose

Oil Cooler Line Assemblies

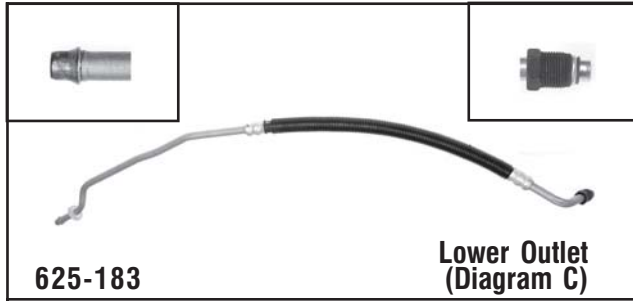

625-183

**Lower Outlet
(Diagram C)**

GM
1998-96 C&K-Series Pickups w/ 4.3L Engine Oil Cooler Lower
Outlet Hose

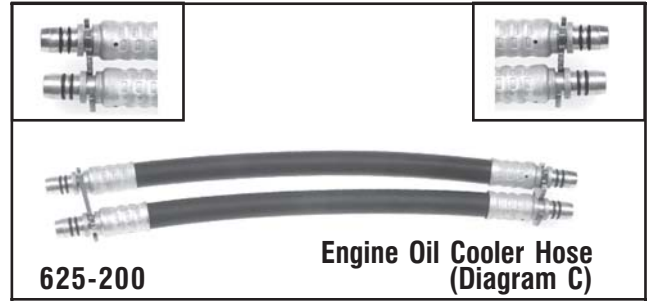

625-200

**Engine Oil Cooler Hose
(Diagram C)**

Ford
2006-96 Crown Victoria, Police Car

Oil Cooler Line Assemblies

Oil Cooler Line Assembly Applications

| Make/ Model/Engine | Years | Description | Dorman # |
|------------------------|---------|--|----------|
| BUICK | | | |
| ROADMASTER | | | |
| V8 - 5.7L (350 CID) | 1996-94 | Eng Oil Cooler Hose | 625-177 |
| CADILLAC | | | |
| ESCALADE | | | |
| V8 - 5.7L (350 CID) | 1999 | Eng Oil Cooler Upper-Inlet Hose | 625-101 |
| V8 - 6.0L (364 CID) | 2005 | Eng Oil Cooler Hose, 7.75MM Length Flared End Tube | 625-168 |
| V8 - 6.0L (364 CID) | 2004-02 | Eng Oil Cooler Hose | 625-168 |
| FLEETWOOD | | | |
| V8 - 5.7L (350 CID) | 1996-94 | RWD, Eng Oil Cooler Hose | 625-177 |
| CHEVROLET | | | |
| CAPRICE | | | |
| V8 - 4.3L (262 CID) | 1996-94 | Eng Oil Cooler Hose | 625-177 |
| V8 - 5.7L (350 CID) | 1996-94 | Exc. Police Car, Eng Oil Cooler Hose | 625-177 |
| V8 - 5.7L (350 CID) | 1996-94 | Police Car, Eng Oil Cooler Hose | 625-124 |
| IMPALA SS | | | |
| V8 - 5.7L (350 CID) | 1996-94 | Eng Oil Cooler Hose | 625-177 |
| CHEVROLET TRUCK | | | |
| ASTRO VAN | | | |
| V6 - 4.3L (262 CID) | 2005-96 | Eng Oil Cooler Hose | 625-105 |
| V6 - 4.3L (262 CID) | 1995 | Eng Oil Cooler Lower-Outlet Hose | 625-144 |
| V6 - 4.3L (262 CID) | 1995 | Eng Oil Cooler Upper-Inlet Hose | 625-138 |
| V6 - 4.3L (262 CID) | 1994 | 2WD, Eng Oil Cooler Lower-Outlet Hose | 625-181 |
| V6 - 4.3L (262 CID) | 1994 | 2WD, Eng Oil Cooler Upper-Inlet Hose | 625-180 |
| V6 - 4.3L (262 CID) | 1993-85 | 2WD, Eng Oil Cooler Lower-Outlet Hose | 625-119 |
| V6 - 4.3L (262 CID) | 1993-85 | 2WD, Eng Oil Cooler Upper-Inlet Hose | 625-118 |
| AVALANCHE | | | |
| V8 - 5.3L (323 CID) | 2005 | Eng Oil Cooler Hose, VIN Z, Flex Fuel, 7.75MM Length Flared End Tube | 625-168 |
| BLAZER | | | |
| V8 - 5.0L (305 CID) | 1987-85 | 4WD, Eng Oil Cooler Lower-Inlet Hose | 625-131 |
| V8 - 5.0L (305 CID) | 1987-85 | 4WD, Eng Oil Cooler Upper-Outlet Hose | 625-132 |
| V8 - 5.7L (350 CID) | 1994 | 2WD, 3.42R, 3.73R, 4.10R, 4.56R, Eng Oil Cooler Lower-Inlet Hose | 625-135 |
| V8 - 5.7L (350 CID) | 1994 | 2WD, 3.42R, 3.73R, 4.10R, 4.56R, Eng Oil Cooler Upper-Outlet Hose | 625-136 |
| V8 - 5.7L (350 CID) | 1994 | 4WD, 3.42R, 3.73R, 4.10R, 4.56R, Eng Oil Cooler Lower-Outlet Hose | 625-107 |
| V8 - 5.7L (350 CID) | 1994 | 4WD, 3.42R, 3.73R, 4.10R, 4.56R, Eng Oil Cooler Upper-Inlet Hose | 625-108 |
| V8 - 5.7L (350 CID) | 1993-92 | 2WD, 3.08R, 3.42R, 3.73R, Eng Oil Cooler Lower-Outlet Hose | 625-140 |
| V8 - 5.7L (350 CID) | 1993-92 | 2WD, 3.08R, 3.42R, 3.73R, Eng Oil Cooler Upper-Inlet Hose | 625-139 |
| V8 - 5.7L (350 CID) | 1993-92 | 2WD, Exc. 3.08R, 3.42R, 3.73R, Eng Oil Cooler Lower-Outlet Hose | 625-161 |
| V8 - 5.7L (350 CID) | 1993-92 | 2WD, Exc. 3.08R, 3.42R, 3.73R, Eng Oil Cooler Upper-Inlet Hose | 625-160 |
| V8 - 5.7L (350 CID) | 1993-92 | 4WD, 3.42R, 3.73R, Eng Oil Cooler Lower-Outlet Hose | 625-142 |
| V8 - 5.7L (350 CID) | 1993-92 | 4WD, 3.42R, 3.73R, Eng Oil Cooler Upper-Inlet Hose | 625-141 |
| V8 - 5.7L (350 CID) | 1993-92 | 4WD, 4.10R, 4.56R, Eng Oil Cooler Lower-Outlet Hose | 625-163 |
| V8 - 5.7L (350 CID) | 1993-92 | 4WD, 4.10R, 4.56R, Eng Oil Cooler Upper-Inlet Hose | 625-162 |
| V8 - 5.7L (350 CID) | 1991-85 | 4WD, Eng Oil Cooler Lower-Inlet Hose | 625-131 |
| V8 - 5.7L (350 CID) | 1991-85 | 4WD, Eng Oil Cooler Upper-Outlet Hose | 625-132 |
| V8 - 6.2L (379 CID) | 1991-85 | Diesel, Eng Oil Cooler Upper-Inlet Hose | 625-154 |
| V8 - 6.5L (395 CID) | 1994 | Diesel, Eng Oil Cooler Upper-Outlet Hose | 625-134 |
| C SERIES PICKUP | | | |
| V6 - 4.3L (262 CID) | 1998-96 | Eng Oil Cooler Lower-Outlet Hose | 625-183 |
| V6 - 4.3L (262 CID) | 1998-96 | Eng Oil Cooler Upper-Inlet Hose | 625-182 |
| V8 - 5.0L (305 CID) | 1999-96 | Eng Oil Cooler Lower-Inlet Hose, w/140 Amp Alternator | 625-149 |
| V8 - 5.0L (305 CID) | 1999-96 | Eng Oil Cooler Upper-Outlet Hose, w/140 Amp Alternator | 625-150 |
| V8 - 5.0L (305 CID) | 1995-94 | 3.08R, 3.42R, 3.73R, 4.10R, Eng Oil Cooler Lower-Outlet Hose | 625-140 |
| V8 - 5.0L (305 CID) | 1995-94 | 3.08R, 3.42R, 3.73R, 4.10R, Eng Oil Cooler Upper-Inlet Hose | 625-139 |
| V8 - 5.0L (305 CID) | 1993-88 | Eng Oil Cooler Lower-Outlet Hose | 625-140 |
| V8 - 5.0L (305 CID) | 1993-88 | Eng Oil Cooler Upper-Inlet Hose | 625-139 |
| V8 - 5.7L (350 CID) | 2000-96 | Eng Oil Cooler Lower-Inlet Hose | 625-149 |
| V8 - 5.7L (350 CID) | 2000-96 | Eng Oil Cooler Upper-Outlet Hose | 625-150 |

**Window
Lift Motors**
pg. 535-554

**Window
Regulators**
pg. 555-566

**Wiper
Motors**
pg. 567-572

**Wiper Transmission
Linkages**
pg. 573-576

**Includes O-Rings, Gaskets, & Connector
Retaining Clips (where required)**

Oil Cooler Line Assemblies

Oil Cooler Line Assembly Applications

| Make/ Model/Engine | Years | Description | Dorman # |
|------------------------------------|---------|---|----------|
| CHEVROLET TRUCK (continued) | | | |
| C SERIES PICKUP (continued) | | | |
| V8 - 5.7L (350 CID) | 1995-94 | 1/2 & 3/4-Ton, 3.08R, 3.42R, 3.73R, 4.10R, 4.56R, Eng Oil Cooler Lower-Inlet Hose | 625-135 |
| V8 - 5.7L (350 CID) | 1995-94 | 1/2 & 3/4-Ton, 3.08R, 3.42R, 3.73R, 4.10R, 4.56R, Eng Oil Cooler Upper-Outlet Hose | 625-136 |
| V8 - 5.7L (350 CID) | 1995 | 1-Ton, 131.5", 155.5" Wheel Base, 3.08R, 3.42R, 3.73R, 4.10R, 4.56R, Eng Oil Cooler Lower-Inlet Hose | 625-135 |
| V8 - 5.7L (350 CID) | 1995 | 1-Ton, 131.5", 155.5" Wheel Base, 3.08R, 3.42R, 3.73R, 4.10R, 4.56R, Eng Oil Cooler Upper-Outlet Hose | 625-136 |
| V8 - 5.7L (350 CID) | 1995 | 1-Ton, 135.5", 159.5" Wheel Base, Eng Oil Cooler Lower-Inlet Hose | 625-135 |
| V8 - 5.7L (350 CID) | 1995 | 1-Ton, 135.5", 159.5" Wheel Base, Eng Oil Cooler Upper-Outlet Hose | 625-136 |
| V8 - 5.7L (350 CID) | 1993-88 | 2.73R, 3.08R, 3.42R, 3.73R, Eng Oil Cooler Lower-Outlet Hose | 625-140 |
| V8 - 5.7L (350 CID) | 1993-88 | 2.73R, 3.08R, 3.42R, 3.73R, Eng Oil Cooler Upper-Inlet Hose | 625-139 |
| V8 - 5.7L (350 CID) | 1993-88 | Exc. 2.73R, 3.08R, 3.42R, 3.73R, Eng Oil Cooler Lower-Outlet Hose | 625-161 |
| V8 - 5.7L (350 CID) | 1993-88 | Exc. 2.73R, 3.08R, 3.42R, 3.73R, Eng Oil Cooler Upper-Inlet Hose | 625-160 |
| V8 - 6.2L (379 CID) | 1993 | Diesel, Eng Oil Cooler Lower-Inlet Hose, w/HD Cooling | 625-164 |
| V8 - 6.2L (379 CID) | 1993 | Diesel, Eng Oil Cooler Lower-Outlet Hose, wo/HD Cooling | 625-157 |
| V8 - 6.2L (379 CID) | 1993 | Diesel, Eng Oil Cooler Upper-Inlet Hose, wo/HD Cooling | 625-165 |
| V8 - 6.2L (379 CID) | 1993 | Diesel, Eng Oil Cooler Upper-Outlet Hose, w/HD Cooling | 625-134 |
| V8 - 6.2L (379 CID) | 1992 | Diesel, Eng Oil Cooler Lower-Inlet Hose, w/HD Cooling, w/Hose Protector | 625-164 |
| V8 - 6.2L (379 CID) | 1992 | Diesel, Eng Oil Cooler Lower-Inlet Hose, w/HD Cooling, wo/Hose Protector | 625-133 |
| V8 - 6.2L (379 CID) | 1992 | Diesel, Eng Oil Cooler Lower-Outlet Hose, wo/HD Cooling | 625-157 |
| V8 - 6.2L (379 CID) | 1992 | Diesel, Eng Oil Cooler Upper-Inlet Hose, wo/HD Cooling | 625-165 |
| V8 - 6.2L (379 CID) | 1992 | Diesel, Eng Oil Cooler Upper-Outlet Hose, w/HD Cooling | 625-134 |
| V8 - 6.2L (379 CID) | 1991-88 | Diesel, Eng Oil Cooler Lower-Inlet Hose, w/HD Cooling | 625-133 |
| V8 - 6.2L (379 CID) | 1991-88 | Diesel, Eng Oil Cooler Lower-Outlet Hose, wo/HD Cooling | 625-157 |
| V8 - 6.2L (379 CID) | 1991-88 | Diesel, Eng Oil Cooler Upper-Inlet Hose, wo/HD Cooling | 625-165 |
| V8 - 6.2L (379 CID) | 1991-88 | Diesel, Eng Oil Cooler Upper-Outlet Hose, w/HD Cooling | 625-134 |
| V8 - 6.2L (379 CID) | 1986-85 | Diesel, Eng Oil Cooler Lower-Outlet Hose | 625-155 |
| V8 - 6.2L (379 CID) | 1986-85 | Diesel, Eng Oil Cooler Upper-Inlet Hose | 625-154 |
| V8 - 6.5L (395 CID) | 2002-01 | Diesel, Eng Oil Cooler LH Side-Inlet Hose (Conn Nut 32mm Across Flats) | 625-113 |
| V8 - 6.5L (395 CID) | 2002-01 | Diesel, Eng Oil Cooler RH Side-Outlet Hose (Conn Nut 32mm Across Flats) | 625-112 |
| V8 - 6.5L (395 CID) | 2000-98 | Diesel, Eng Oil Cooler LH Side-Inlet Hose (Conn Nut 27mm Across Flats) | 625-147 |
| V8 - 6.5L (395 CID) | 2000-98 | Diesel, Eng Oil Cooler LH Side-Inlet Hose (Conn Nut 32mm Across Flats) | 625-113 |
| V8 - 6.5L (395 CID) | 2000-98 | Diesel, Eng Oil Cooler RH Side-Outlet Hose (Conn Nut 27mm Across Flats) | 625-148 |
| V8 - 6.5L (395 CID) | 2000-98 | Diesel, Eng Oil Cooler RH Side-Outlet Hose (Conn Nut 32mm Across Flats) | 625-112 |
| V8 - 6.5L (395 CID) | 1997 | Diesel, 1-Ton, Eng Oil Cooler LH Side-Inlet Hose (Conn Nut .875" Across Flats), Exc. 15,000 GVW | 625-143 |
| V8 - 6.5L (395 CID) | 1997 | Diesel, 1-Ton, Eng Oil Cooler LH Side-Inlet Hose (Conn Nut 25.4mm Across Flats), 15,000 GVW | 625-145 |
| V8 - 6.5L (395 CID) | 1997 | Diesel, 1-Ton, Eng Oil Cooler LH Side-Inlet Hose (Conn Nut 27mm Across Flats), Exc. 15,000 GVW | 625-147 |
| V8 - 6.5L (395 CID) | 1997 | Diesel, 1-Ton, Eng Oil Cooler LH Side-Inlet Hose (Conn Nut 32mm Across Flats) | 625-113 |
| V8 - 6.5L (395 CID) | 1997 | Diesel, 1-Ton, Eng Oil Cooler RH Side-Outlet Hose (Conn Nut 19mm Across Flats), Exc. 15,000 GVW | 625-114 |
| V8 - 6.5L (395 CID) | 1997 | Diesel, 1-Ton, Eng Oil Cooler RH Side-Outlet Hose (Conn Nut 25.4mm Across Flats), 15,000 GVW | 625-146 |
| V8 - 6.5L (395 CID) | 1997 | Diesel, 1-Ton, Eng Oil Cooler RH Side-Outlet Hose (Conn Nut 27mm Across Flats), Exc. 15,000 GVW | 625-148 |
| V8 - 6.5L (395 CID) | 1997 | Diesel, 1-Ton, Eng Oil Cooler RH Side-Outlet Hose (Conn Nut 32mm Across Flats) | 625-112 |
| V8 - 6.5L (395 CID) | 1997 | Diesel, 1/2 & 3/4-Ton, Eng Oil Cooler LH Side-Inlet Hose (Conn Nut .875" Across Flats) | 625-143 |
| V8 - 6.5L (395 CID) | 1997 | Diesel, 1/2 & 3/4-Ton, Eng Oil Cooler LH Side-Inlet Hose (Conn Nut 27mm Across Flats) | 625-147 |
| V8 - 6.5L (395 CID) | 1997 | Diesel, 1/2 & 3/4-Ton, Eng Oil Cooler RH Side-Outlet Hose (Conn Nut 19mm Across Flats) | 625-114 |
| V8 - 6.5L (395 CID) | 1997 | Diesel, 1/2 & 3/4-Ton, Eng Oil Cooler RH Side-Outlet Hose (Conn Nut 27mm Across Flats) | 625-148 |
| V8 - 6.5L (395 CID) | 1996-95 | Diesel, 1-Ton, Eng Oil Cooler LH Side-Inlet Hose (Conn Nut .875" Across Flats), Exc. 15,000 GVW | 625-143 |
| V8 - 6.5L (395 CID) | 1996-95 | Diesel, 1-Ton, Eng Oil Cooler LH Side-Inlet Hose (Conn Nut 25.4mm Across Flats), 15,000 GVW | 625-145 |
| V8 - 6.5L (395 CID) | 1996-95 | Diesel, 1-Ton, Eng Oil Cooler RH Side-Outlet Hose (Conn Nut 19mm Across Flats), Exc. 15,000 GVW | 625-114 |
| V8 - 6.5L (395 CID) | 1996-95 | Diesel, 1-Ton, Eng Oil Cooler RH Side-Outlet Hose (Conn Nut 25.4mm Across Flats), 15,000 GVW | 625-146 |
| V8 - 6.5L (395 CID) | 1996-95 | Diesel, 1/2 & 3/4-Ton, Eng Oil Cooler LH Side-Inlet Hose (Conn Nut .875" Across Flats) | 625-143 |
| V8 - 6.5L (395 CID) | 1996-95 | Diesel, 1/2 & 3/4-Ton, Eng Oil Cooler RH Side-Outlet Hose (Conn Nut 19mm Across Flats) | 625-114 |
| V8 - 6.5L (395 CID) | 1994-92 | Diesel, Eng Oil Cooler Lower-Inlet Hose, Under 12,000 GVW | 625-164 |
| V8 - 6.5L (395 CID) | 1994-92 | Diesel, Eng Oil Cooler Upper-Outlet Hose, Under 12,000 GVW | 625-134 |
| V8 - 6.5L (395 CID) | 1993-92 | Diesel, Eng Oil Cooler Lower-Outlet Hose, 15,000 GVW & Over | 625-157 |
| V8 - 7.4L (454 CID) | 2000-96 | Eng Oil Cooler Lower-Inlet Hose, Under 12,000 GVW | 625-178 |
| V8 - 7.4L (454 CID) | 2000-96 | Eng Oil Cooler Upper-Outlet Hose | 625-179 |
| V8 - 7.4L (454 CID) | 1995-94 | Eng Oil Cooler Lower-Inlet Hose, wo/HD Cooling | 625-137 |
| V8 - 7.4L (454 CID) | 1995-94 | Eng Oil Cooler Upper-Outlet Hose, wo/HD Cooling | 625-111 |
| V8 - 7.4L (454 CID) | 1993 | Eng Oil Cooler Lower-Inlet Hose, wo/HD Cooling | 625-158 |
| V8 - 7.4L (454 CID) | 1993 | Eng Oil Cooler Upper-Outlet Hose, wo/HD Cooling | 625-159 |
| V8 - 7.4L (454 CID) | 1992 | Eng Oil Cooler Lower-Inlet Hose, w/Upper Radiator Shroud Broadcast Code AFB, wo/HD Cooling | 625-158 |
| V8 - 7.4L (454 CID) | 1992 | Eng Oil Cooler Upper-Outlet Hose, w/Upper Radiator Shroud Broadcast Code AFB, wo/HD Cooling | 625-159 |
| V8 - 8.1L (496 CID) | 2003-01 | Eng Oil Cooler Lower-Outlet Hose | 625-167 |
| V8 - 8.1L (496 CID) | 2003-01 | Eng Oil Cooler Upper-Inlet Hose | 625-166 |
| EXPRESS VAN | | | |
| V6 - 4.3L (262 CID) | 2002-96 | Eng Oil Cooler Hose | 625-175 |
| V8 - 5.7L (350 CID) | 2002-96 | Eng Oil Cooler Lower-Outlet Hose | 625-152 |
| V8 - 5.7L (350 CID) | 2002-96 | Eng Oil Cooler Upper-Inlet Hose | 625-151 |
| V8 - 6.0L (364 CID) | 2004-03 | Eng Oil Cooler Hose | 625-168 |

Oil Cooler Line Assembly Applications

| Make/ Model/Engine | Years | Description | Dorman # |
|------------------------------------|---------|---|----------|
| CHEVROLET TRUCK (continued) | | | |
| EXPRESS VAN (continued) | | | |
| V8 - 6.5L (395 CID) | 2002-96 | Diesel, Auxiliary Eng Oil Cooler Lower-Outlet Hose | 625-130 |
| V8 - 6.5L (395 CID) | 2002-96 | Diesel, Auxiliary Eng Oil Cooler Upper-Inlet Hose | 625-106 |
| V8 - 6.5L (395 CID) | 2002-96 | Diesel, Eng Oil Cooler Lower-Inlet Hose | 625-129 |
| G SERIES VAN | | | |
| V6 - 4.3L (262 CID) | 1997 | Eng Oil Cooler Hose | 625-175 |
| V6 - 4.3L (262 CID) | 1996-94 | Eng Oil Cooler Lower-Inlet Hose, w/HD Cooling | 625-171 |
| V6 - 4.3L (262 CID) | 1996-94 | Eng Oil Cooler Upper-Outlet Hose, w/HD Cooling | 625-172 |
| V6 - 4.3L (262 CID) | 1993-92 | Eng Oil Cooler Lower-Inlet Hose, A/C Manual Control | 625-171 |
| V6 - 4.3L (262 CID) | 1993-92 | Eng Oil Cooler Lower-Outlet Hose, Exc. A/C Manual Control | 625-170 |
| V6 - 4.3L (262 CID) | 1993-92 | Eng Oil Cooler Upper-Inlet Hose, Exc. A/C Manual Control | 625-169 |
| V6 - 4.3L (262 CID) | 1993-92 | Eng Oil Cooler Upper-Outlet Hose, A/C Manual Control | 625-172 |
| V6 - 4.3L (262 CID) | 1991-85 | Eng Oil Cooler Lower-Outlet Hose | 625-170 |
| V6 - 4.3L (262 CID) | 1991-85 | Eng Oil Cooler Upper-Inlet Hose | 625-169 |
| V8 - 5.0L (305 CID) | 1995-92 | Eng Oil Cooler Inlet Hose | 625-153 |
| V8 - 5.0L (305 CID) | 1995-92 | Eng Oil Cooler Outlet Hose | 625-153 |
| V8 - 5.0L (305 CID) | 1991-87 | Eng Oil Cooler LH Side-Outlet Hose | 625-121 |
| V8 - 5.0L (305 CID) | 1991-87 | Eng Oil Cooler RH Side-Inlet Hose | 625-120 |
| V8 - 5.7L (350 CID) | 1996 | Eng Vin K, Eng Oil Cooler Inlet Hose | 625-153 |
| V8 - 5.7L (350 CID) | 1996 | Eng Vin K, Eng Oil Cooler Outlet Hose | 625-153 |
| V8 - 5.7L (350 CID) | 1996 | Eng Vin R, Eng Oil Cooler Lower-Outlet Hose | 625-152 |
| V8 - 5.7L (350 CID) | 1996 | Eng Vin R, Eng Oil Cooler Upper-Inlet Hose | 625-151 |
| V8 - 5.7L (350 CID) | 1995-92 | Eng Oil Cooler Inlet Hose | 625-153 |
| V8 - 5.7L (350 CID) | 1995-92 | Eng Oil Cooler Outlet Hose | 625-153 |
| V8 - 5.7L (350 CID) | 1991-87 | Eng Oil Cooler LH Side-Outlet Hose | 625-121 |
| V8 - 5.7L (350 CID) | 1991-87 | Eng Oil Cooler RH Side-Inlet Hose | 625-120 |
| V8 - 5.7L (350 CID) | 1986-85 | Eng Vin M, Eng Oil Cooler LH Side-Outlet Hose | 625-121 |
| V8 - 5.7L (350 CID) | 1986-85 | Eng Vin M, Eng Oil Cooler RH Side-Inlet Hose | 625-120 |
| V8 - 6.2L (379 CID) | 1993-92 | Diesel, Eng Oil Cooler Lower-Inlet Hose | 625-173 |
| V8 - 6.2L (379 CID) | 1993-92 | Diesel, Eng Oil Cooler Upper-Outlet Hose | 625-174 |
| V8 - 6.2L (379 CID) | 1991-85 | Diesel, Eng Oil Cooler Lower-Outlet Hose | 625-126 |
| V8 - 6.2L (379 CID) | 1991-85 | Diesel, Eng Oil Cooler Upper-Inlet Hose | 625-125 |
| V8 - 6.5L (395 CID) | 1996-94 | Diesel, Eng Oil Cooler Lower-Inlet Pipe | 625-110 |
| V8 - 6.5L (395 CID) | 1996-94 | Diesel, Eng Oil Cooler Upper-Outlet Pipe | 625-109 |
| V8 - 6.5L (395 CID) | 1996 | Diesel, Auxiliary Eng Oil Cooler Lower-Outlet Hose | 625-130 |
| V8 - 6.5L (395 CID) | 1996 | Diesel, Auxiliary Eng Oil Cooler Upper-Inlet Hose | 625-106 |
| V8 - 6.5L (395 CID) | 1996 | Diesel, Eng Oil Cooler Lower-Inlet Hose | 625-129 |
| K SERIES PICKUP | | | |
| V6 - 4.3L (262 CID) | 1998-96 | Eng Oil Cooler Lower-Outlet Hose | 625-183 |
| V6 - 4.3L (262 CID) | 1998-96 | Eng Oil Cooler Upper-Inlet Hose | 625-182 |
| V8 - 5.0L (305 CID) | 1999-96 | Eng Oil Cooler Lower-Outlet Hose, w/140 Amp Alternator | 625-123 |
| V8 - 5.0L (305 CID) | 1999-96 | Eng Oil Cooler Upper-Inlet Hose, w/140 Amp Alternator | 625-101 |
| V8 - 5.0L (305 CID) | 1995-94 | 3.42R, 3.73R, Eng Oil Cooler Lower-Outlet Hose | 625-142 |
| V8 - 5.0L (305 CID) | 1995-94 | 3.42R, 3.73R, Eng Oil Cooler Upper-Inlet Hose | 625-141 |
| V8 - 5.0L (305 CID) | 1993-88 | Eng Oil Cooler Lower-Outlet Hose | 625-142 |
| V8 - 5.0L (305 CID) | 1993-88 | Eng Oil Cooler Upper-Inlet Hose | 625-141 |
| V8 - 5.0L (305 CID) | 1986-85 | Eng Oil Cooler Lower-Inlet Hose | 625-131 |
| V8 - 5.0L (305 CID) | 1986-85 | Eng Oil Cooler Upper-Outlet Hose | 625-132 |
| V8 - 5.7L (350 CID) | 2000-96 | Eng Oil Cooler Lower-Outlet Hose | 625-123 |
| V8 - 5.7L (350 CID) | 2000-96 | Eng Oil Cooler Upper-Inlet Hose | 625-101 |
| V8 - 5.7L (350 CID) | 1995-94 | 1-Ton, 131.5", 155.5" Wheel Base, 3.73R, 4.10R, 4.56R, Eng Oil Cooler Lower-Outlet Hose | 625-107 |
| V8 - 5.7L (350 CID) | 1995-94 | 1-Ton, 131.5", 155.5" Wheel Base, 3.73R, 4.10R, 4.56R, Eng Oil Cooler Upper-Inlet Hose | 625-108 |
| V8 - 5.7L (350 CID) | 1995-94 | 1-Ton, 135.5", 159.5" Wheel Base, Eng Oil Cooler Lower-Outlet Hose | 625-107 |
| V8 - 5.7L (350 CID) | 1995-94 | 1-Ton, 135.5", 159.5" Wheel Base, Eng Oil Cooler Upper-Inlet Hose | 625-108 |
| V8 - 5.7L (350 CID) | 1995-94 | 1/2 & 3/4-Ton, 3.42R, 3.73R, 4.10R, 4.56R, Eng Oil Cooler Lower-Outlet Hose | 625-107 |
| V8 - 5.7L (350 CID) | 1995-94 | 1/2 & 3/4-Ton, 3.42R, 3.73R, 4.10R, 4.56R, Eng Oil Cooler Upper-Inlet Hose | 625-108 |
| V8 - 5.7L (350 CID) | 1993-91 | 4.10R, 4.56R, Eng Oil Cooler Lower-Outlet Hose | 625-163 |
| V8 - 5.7L (350 CID) | 1993-91 | 4.10R, 4.56R, Eng Oil Cooler Upper-Inlet Hose | 625-162 |
| V8 - 5.7L (350 CID) | 1993-88 | 3.42R, 3.73R, Eng Oil Cooler Lower-Outlet Hose | 625-142 |
| V8 - 5.7L (350 CID) | 1993-88 | 3.42R, 3.73R, Eng Oil Cooler Upper-Inlet Hose | 625-141 |
| V8 - 5.7L (350 CID) | 1986-85 | Eng Oil Cooler Lower-Inlet Hose | 625-131 |
| V8 - 5.7L (350 CID) | 1986-85 | Eng Oil Cooler Upper-Outlet Hose | 625-132 |
| V8 - 6.2L (379 CID) | 1993 | Diesel, Eng Oil Cooler Lower-Inlet Hose, w/HD Cooling | 625-164 |
| V8 - 6.2L (379 CID) | 1993 | Diesel, Eng Oil Cooler Lower-Outlet Hose, wo/HD Cooling | 625-157 |
| V8 - 6.2L (379 CID) | 1993 | Diesel, Eng Oil Cooler Upper-Inlet Hose, wo/HD Cooling | 625-165 |
| V8 - 6.2L (379 CID) | 1993 | Diesel, Eng Oil Cooler Upper-Outlet Hose, w/HD Cooling | 625-134 |
| V8 - 6.2L (379 CID) | 1992 | Diesel, Eng Oil Cooler Lower-Inlet Hose, w/HD Cooling, w/Hose Protector | 625-164 |
| V8 - 6.2L (379 CID) | 1992 | Diesel, Eng Oil Cooler Lower-Inlet Hose, w/HD Cooling, wo/Hose Protector | 625-133 |
| V8 - 6.2L (379 CID) | 1992 | Diesel, Eng Oil Cooler Lower-Outlet Hose, wo/HD Cooling | 625-157 |
| V8 - 6.2L (379 CID) | 1992 | Diesel, Eng Oil Cooler Upper-Inlet Hose, wo/HD Cooling | 625-165 |
| V8 - 6.2L (379 CID) | 1992 | Diesel, Eng Oil Cooler Upper-Outlet Hose, w/HD Cooling | 625-134 |
| V8 - 6.2L (379 CID) | 1991-88 | Diesel, Eng Oil Cooler Lower-Inlet Hose, w/HD Cooling | 625-133 |
| V8 - 6.2L (379 CID) | 1991-88 | Diesel, Eng Oil Cooler Lower-Outlet Hose, wo/HD Cooling | 625-157 |
| V8 - 6.2L (379 CID) | 1991-88 | Diesel, Eng Oil Cooler Upper-Inlet Hose, wo/HD Cooling | 625-165 |
| V8 - 6.2L (379 CID) | 1991-88 | Diesel, Eng Oil Cooler Upper-Outlet Hose, w/HD Cooling | 625-134 |
| V8 - 6.2L (379 CID) | 1986-85 | Diesel, Eng Oil Cooler Lower-Outlet Hose | 625-155 |
| V8 - 6.2L (379 CID) | 1986-85 | Diesel, Eng Oil Cooler Upper-Inlet Hose | 625-154 |
| V8 - 6.5L (395 CID) | 2000-98 | Diesel, Eng Oil Cooler LH Side-Inlet Hose (Conn Nut 27mm Across Flats) | 625-147 |
| V8 - 6.5L (395 CID) | 2000-98 | Diesel, Eng Oil Cooler RH Side-Outlet Hose (Conn Nut 27mm Across Flats) | 625-148 |
| V8 - 6.5L (395 CID) | 1997 | Diesel, Eng Oil Cooler LH Side-Inlet Hose (Conn Nut .875" Across Flats) | 625-143 |
| V8 - 6.5L (395 CID) | 1997 | Diesel, Eng Oil Cooler LH Side-Inlet Hose (Conn Nut 27mm Across Flats) | 625-147 |
| V8 - 6.5L (395 CID) | 1997 | Diesel, Eng Oil Cooler RH Side-Outlet Hose (Conn Nut 19mm Across Flats) | 625-114 |

Oil Cooler Line Assembly Applications

| Make/ Model/Engine | Years | Description | Dorman # |
|------------------------------------|---------|---|----------|
| CHEVROLET TRUCK (continued) | | | |
| K SERIES PICKUP (continued) | | | |
| V8 - 6.5L (395 CID) | 1997 | Diesel, Eng Oil Cooler RH Side-Outlet Hose (Conn Nut 27mm Across Flats) | 625-148 |
| V8 - 6.5L (395 CID) | 1996-95 | Diesel, Eng Oil Cooler LH Side-Inlet Hose (Conn Nut .875" Across Flats) | 625-143 |
| V8 - 6.5L (395 CID) | 1996-95 | Diesel, Eng Oil Cooler RH Side-Outlet Hose (Conn Nut 19mm Across Flats) | 625-114 |
| V8 - 6.5L (395 CID) | 1994-92 | Diesel, Eng Oil Cooler Lower-Inlet Hose, Under 12,000 GVW | 625-164 |
| V8 - 6.5L (395 CID) | 1994-92 | Diesel, Eng Oil Cooler Upper-Outlet Hose, Under 12,000 GVW | 625-134 |
| V8 - 7.4L (454 CID) | 2000-96 | Eng Oil Cooler Lower-Inlet Hose, Under 12,000 GVW | 625-178 |
| V8 - 7.4L (454 CID) | 2000-96 | Eng Oil Cooler Upper-Outlet Hose | 625-179 |
| V8 - 7.4L (454 CID) | 1995-94 | Eng Oil Cooler Lower-Inlet Hose, wo/HD Cooling | 625-137 |
| V8 - 7.4L (454 CID) | 1995-94 | Eng Oil Cooler Upper-Outlet Hose, wo/HD Cooling | 625-111 |
| V8 - 7.4L (454 CID) | 1986-85 | Eng Oil Cooler Lower-Inlet Hose | 625-131 |
| V8 - 7.4L (454 CID) | 1986-85 | Eng Oil Cooler Upper-Outlet Hose | 625-132 |
| R SERIES PICKUP | | | |
| V8 - 6.2L (379 CID) | 1991-87 | Diesel, Eng Oil Cooler Lower-Outlet Hose | 625-155 |
| V8 - 6.2L (379 CID) | 1991-87 | Diesel, Eng Oil Cooler Upper-Inlet Hose | 625-154 |
| S10 BLAZER | | | |
| V6 - 4.3L (262 CID) | 2005-96 | 2WD, Eng Oil Cooler Hose | 625-122 |
| V6 - 4.3L (262 CID) | 2005-96 | 4WD, Eng Oil Cooler Pipe | 625-100 |
| V6 - 4.3L (262 CID) | 2005-96 | 4WD, Eng Oil Filter Hose | 625-001 |
| V6 - 4.3L (262 CID) | 1995 | 2WD, Eng Oil Cooler Lower-Outlet Hose | 625-128 |
| V6 - 4.3L (262 CID) | 1995 | 2WD, Eng Oil Cooler Upper-Inlet Hose | 625-127 |
| V6 - 4.3L (262 CID) | 1995 | 4WD, Eng Oil Cooler Hose | 625-104 |
| V6 - 4.3L (262 CID) | 1995 | 4WD, Eng Oil Filter Hose | 625-103 |
| V6 - 4.3L (262 CID) | 1994-92 | 4WD, Eng Vin Z, Eng Oil Cooler Hose, w/HD Cooling | 625-176 |
| V6 - 4.3L (262 CID) | 1994-88 | 4WD, Eng Oil Filter Hose | 625-102 |
| V6 - 4.3L (262 CID) | 1991-88 | 4WD, Eng Vin Z, Eng Oil Cooler Hose | 625-176 |
| S10 PICKUP | | | |
| V6 - 4.3L (262 CID) | 2004-96 | 2WD, Eng Oil Cooler Hose | 625-122 |
| V6 - 4.3L (262 CID) | 2004-96 | 4WD, Eng Oil Cooler Pipe | 625-100 |
| V6 - 4.3L (262 CID) | 2004-96 | 4WD, Eng Oil Filter Hose | 625-001 |
| V6 - 4.3L (262 CID) | 1995-94 | 2WD, Eng Oil Cooler Lower-Outlet Hose | 625-128 |
| V6 - 4.3L (262 CID) | 1995-94 | 2WD, Eng Oil Cooler Upper-Inlet Hose | 625-127 |
| V6 - 4.3L (262 CID) | 1995-94 | 4WD, Eng Oil Cooler Hose | 625-104 |
| V6 - 4.3L (262 CID) | 1995-94 | 4WD, Eng Oil Filter Hose | 625-103 |
| V6 - 4.3L (262 CID) | 1993-88 | 4WD, Eng Oil Filter Hose | 625-102 |
| SILVERADO | | | |
| V8 - 5.3L (323 CID) | 2005 | Eng Oil Cooler Hose, VIN Z, Flex Fuel, 7.75MM Length Flared End Tube | 625-168 |
| V8 - 6.0L (364 CID) | 2005 | Eng Oil Cooler Hose, 7.75MM Length Flared End Tube | 625-168 |
| V8 - 6.0L (364 CID) | 2004-99 | Eng Oil Cooler Hose | 625-168 |
| SUBURBAN | | | |
| V8 - 5.0L (305 CID) | 1986-85 | 4WD, Eng Oil Cooler Lower-Inlet Hose | 625-131 |
| V8 - 5.0L (305 CID) | 1986-85 | 4WD, Eng Oil Cooler Upper-Outlet Hose | 625-132 |
| V8 - 5.3L (323 CID) | 2005 | Eng Oil Cooler Hose, VIN Z, Flex Fuel, 7.75MM Length Flared End Tube | 625-168 |
| V8 - 5.7L (350 CID) | 1999-96 | 2WD, Eng Oil Cooler Lower-Inlet Hose | 625-149 |
| V8 - 5.7L (350 CID) | 1999-96 | 2WD, Eng Oil Cooler Upper-Outlet Hose | 625-150 |
| V8 - 5.7L (350 CID) | 1999-96 | 4WD, Eng Oil Cooler Lower-Outlet Hose | 625-123 |
| V8 - 5.7L (350 CID) | 1999-96 | 4WD, Eng Oil Cooler Upper-Inlet Hose | 625-101 |
| V8 - 5.7L (350 CID) | 1995-94 | 2WD, 3.08R, 3.42R, 3.73R, 4.10R, 4.56R, Eng Oil Cooler Lower-Inlet Hose | 625-135 |
| V8 - 5.7L (350 CID) | 1995-94 | 2WD, 3.08R, 3.42R, 3.73R, 4.10R, 4.56R, Eng Oil Cooler Upper-Outlet Hose | 625-136 |
| V8 - 5.7L (350 CID) | 1995-94 | 4WD, 3.42R, 3.73R, 4.10R, 4.56R, Eng Oil Cooler Lower-Outlet Hose | 625-107 |
| V8 - 5.7L (350 CID) | 1995-94 | 4WD, 3.42R, 3.73R, 4.10R, 4.56R, Eng Oil Cooler Upper-Inlet Hose | 625-108 |
| V8 - 5.7L (350 CID) | 1993-92 | 2WD, 3.08R, 3.42R, 3.73R, Eng Oil Cooler Lower-Outlet Hose | 625-140 |
| V8 - 5.7L (350 CID) | 1993-92 | 2WD, 3.08R, 3.42R, 3.73R, Eng Oil Cooler Upper-Inlet Hose | 625-139 |
| V8 - 5.7L (350 CID) | 1993-92 | 2WD, Exc. 3.08R, 3.42R, 3.73R, Eng Oil Cooler Lower-Outlet Hose | 625-161 |
| V8 - 5.7L (350 CID) | 1993-92 | 2WD, Exc. 3.08R, 3.42R, 3.73R, Eng Oil Cooler Upper-Inlet Hose | 625-160 |
| V8 - 5.7L (350 CID) | 1993-92 | 4WD, 3.42R, 3.73R, Eng Oil Cooler Lower-Outlet Hose | 625-142 |
| V8 - 5.7L (350 CID) | 1993-92 | 4WD, 3.42R, 3.73R, Eng Oil Cooler Upper-Inlet Hose | 625-141 |
| V8 - 5.7L (350 CID) | 1993-92 | 4WD, 4.10R, 4.56R, Eng Oil Cooler Lower-Outlet Hose | 625-163 |
| V8 - 5.7L (350 CID) | 1993-92 | 4WD, 4.10R, 4.56R, Eng Oil Cooler Upper-Inlet Hose | 625-162 |
| V8 - 5.7L (350 CID) | 1991-85 | 4WD, Eng Oil Cooler Lower-Inlet Hose | 625-131 |
| V8 - 5.7L (350 CID) | 1991-85 | 4WD, Eng Oil Cooler Upper-Outlet Hose | 625-132 |
| V8 - 6.0L (364 CID) | 2005 | Eng Oil Cooler Hose, 7.75MM Length Flared End Tube | 625-168 |
| V8 - 6.0L (364 CID) | 2004-00 | Eng Oil Cooler Hose | 625-168 |
| V8 - 6.2L (379 CID) | 1993 | Diesel, Eng Oil Cooler Lower-Inlet Hose, w/HD Cooling | 625-164 |
| V8 - 6.2L (379 CID) | 1993 | Diesel, Eng Oil Cooler Lower-Outlet Hose, wo/HD Cooling | 625-157 |
| V8 - 6.2L (379 CID) | 1993 | Diesel, Eng Oil Cooler Upper-Inlet Hose, wo/HD Cooling | 625-165 |
| V8 - 6.2L (379 CID) | 1993 | Diesel, Eng Oil Cooler Upper-Outlet Hose, w/HD Cooling | 625-134 |
| V8 - 6.2L (379 CID) | 1992 | Diesel, Eng Oil Cooler Lower-Inlet Hose, w/HD Cooling, w/Hose Protector | 625-164 |
| V8 - 6.2L (379 CID) | 1992 | Diesel, Eng Oil Cooler Lower-Outlet Hose, w/HD Cooling, wo/Hose Protector | 625-133 |
| V8 - 6.2L (379 CID) | 1992 | Diesel, Eng Oil Cooler Lower-Outlet Hose, wo/HD Cooling | 625-157 |
| V8 - 6.2L (379 CID) | 1992 | Diesel, Eng Oil Cooler Upper-Inlet Hose, wo/HD Cooling | 625-165 |
| V8 - 6.2L (379 CID) | 1992 | Diesel, Eng Oil Cooler Upper-Outlet Hose, w/HD Cooling | 625-134 |
| V8 - 6.2L (379 CID) | 1991-87 | Diesel, Eng Oil Cooler Lower-Outlet Hose | 625-155 |
| V8 - 6.2L (379 CID) | 1991-87 | Diesel, Eng Oil Cooler Upper-Inlet Hose | 625-154 |
| V8 - 6.2L (379 CID) | 1986-85 | Diesel, Eng Oil Cooler Lower-Outlet Hose | 625-155 |
| V8 - 6.2L (379 CID) | 1986-85 | Diesel, Eng Oil Cooler Upper-Inlet Hose | 625-154 |
| V8 - 6.5L (395 CID) | 1999-98 | Diesel, Eng Oil Cooler LH Side-Inlet Hose (Conn Nut 27mm Across Flats) | 625-147 |
| V8 - 6.5L (395 CID) | 1999-98 | Diesel, Eng Oil Cooler RH Side-Outlet Hose (Conn Nut 27mm Across Flats) | 625-148 |
| V8 - 6.5L (395 CID) | 1997 | Diesel, Eng Oil Cooler LH Side-Inlet Hose (Conn Nut .875" Across Flats) | 625-143 |
| V8 - 6.5L (395 CID) | 1997 | Diesel, Eng Oil Cooler LH Side-Inlet Hose (Conn Nut 27mm Across Flats) | 625-147 |
| V8 - 6.5L (395 CID) | 1997 | Diesel, Eng Oil Cooler RH Side-Outlet Hose (Conn Nut 19mm Across Flats) | 625-114 |
| V8 - 6.5L (395 CID) | 1997 | Diesel, Eng Oil Cooler RH Side-Outlet Hose (Conn Nut 27mm Across Flats) | 625-148 |

Oil Cooler Line Assembly Applications

| Make/ Model/Engine | Years | Description | Dorman # |
|------------------------------------|---------|--|----------|
| CHEVROLET TRUCK (continued) | | | |
| SUBURBAN (continued) | | | |
| V8 - 6.5L (395 CID) | 1996-95 | Diesel, Eng Oil Cooler LH Side-Inlet Hose | 625-143 |
| V8 - 6.5L (395 CID) | 1996-95 | Diesel, Eng Oil Cooler RH Side-Outlet Hose | 625-114 |
| V8 - 6.5L (395 CID) | 1994-92 | Diesel, Eng Oil Cooler Lower-Inlet Hose, Under 12,000 GVW | 625-164 |
| V8 - 6.5L (395 CID) | 1994-92 | Diesel, Eng Oil Cooler Upper-Outlet Hose, Under 12,000 GVW | 625-134 |
| V8 - 7.4L (454 CID) | 1999-96 | Eng Oil Cooler Lower-Inlet Hose, Under 12,000 GVW | 625-178 |
| V8 - 7.4L (454 CID) | 1999-96 | Eng Oil Cooler Upper-Outlet Hose | 625-179 |
| V8 - 7.4L (454 CID) | 1995-94 | Eng Oil Cooler Lower-Inlet Hose, wo/HD Cooling | 625-137 |
| V8 - 7.4L (454 CID) | 1995-94 | Eng Oil Cooler Upper-Outlet Hose, wo/HD Cooling | 625-111 |
| V8 - 7.4L (454 CID) | 1993 | Eng Oil Cooler Lower-Inlet Hose, wo/HD Cooling | 625-158 |
| V8 - 7.4L (454 CID) | 1993 | Eng Oil Cooler Upper-Outlet Hose, wo/HD Cooling | 625-159 |
| V8 - 7.4L (454 CID) | 1992 | Eng Oil Cooler Lower-Inlet Hose, w/Upper Radiator Shroud Broadcast Code AFB, wo/HD Cooling | 625-158 |
| V8 - 7.4L (454 CID) | 1992 | Eng Oil Cooler Upper-Outlet Hose, w/Upper Radiator Shroud Broadcast Code AFB, wo/HD Cooling | 625-159 |
| V8 - 7.4L (454 CID) | 1990-85 | 4WD, Eng Oil Cooler Lower-Inlet Hose | 625-131 |
| V8 - 7.4L (454 CID) | 1990-85 | 4WD, Eng Oil Cooler Upper-Outlet Hose | 625-132 |
| TAHOE | | | |
| V8 - 5.3L (323 CID) | 2005 | Eng Oil Cooler Hose, VIN Z, Flex Fuel, 7.75MM Length Flared End Tube | 625-168 |
| V8 - 5.7L (350 CID) | 2000-96 | 2WD, Eng Oil Cooler Lower-Inlet Hose | 625-149 |
| V8 - 5.7L (350 CID) | 2000-96 | 2WD, Eng Oil Cooler Upper-Outlet Hose | 625-150 |
| V8 - 5.7L (350 CID) | 2000-96 | 4WD, Eng Oil Cooler Lower-Outlet Hose | 625-123 |
| V8 - 5.7L (350 CID) | 2000-96 | 4WD, Eng Oil Cooler Upper-Inlet Hose | 625-101 |
| V8 - 5.7L (350 CID) | 1995 | 2WD, 3.08R, 3.42R, 3.73R, 4.10R, 4.56R, Eng Oil Cooler Lower-Inlet Hose | 625-135 |
| V8 - 5.7L (350 CID) | 1995 | 2WD, 3.08R, 3.42R, 3.73R, 4.10R, 4.56R, Eng Oil Cooler Upper-Outlet Hose | 625-136 |
| V8 - 5.7L (350 CID) | 1995 | 4WD, 3.42R, 3.73R, 4.10R, 4.56R, Eng Oil Cooler Lower-Outlet Hose | 625-107 |
| V8 - 5.7L (350 CID) | 1995 | 4WD, 3.42R, 3.73R, 4.10R, 4.56R, Eng Oil Cooler Upper-Inlet Hose | 625-108 |
| V8 - 6.5L (395 CID) | 1999-98 | Diesel, Eng Oil Cooler LH Side-Inlet Hose (Conn Nut 27mm Across Flats) | 625-147 |
| V8 - 6.5L (395 CID) | 1999-98 | Diesel, Eng Oil Cooler RH Side-Outlet Hose (Conn Nut 27mm Across Flats) | 625-148 |
| V8 - 6.5L (395 CID) | 1997 | Diesel, Eng Oil Cooler LH Side-Inlet Hose (Conn Nut .875" Across Flats) | 625-143 |
| V8 - 6.5L (395 CID) | 1997 | Diesel, Eng Oil Cooler LH Side-Inlet Hose (Conn Nut 27mm Across Flats) | 625-147 |
| V8 - 6.5L (395 CID) | 1997 | Diesel, Eng Oil Cooler RH Side-Outlet Hose (Conn Nut 19mm Across Flats) | 625-114 |
| V8 - 6.5L (395 CID) | 1997 | Diesel, Eng Oil Cooler RH Side-Outlet Hose (Conn Nut 27mm Across Flats) | 625-148 |
| V8 - 6.5L (395 CID) | 1996-95 | Diesel, Eng Oil Cooler LH Side-Inlet Hose | 625-143 |
| V8 - 6.5L (395 CID) | 1996-95 | Diesel, Eng Oil Cooler RH Side-Outlet Hose | 625-114 |
| V SERIES PICKUP | | | |
| V8 - 5.0L (305 CID) | 1987 | Eng Oil Cooler Lower-Inlet Hose | 625-131 |
| V8 - 5.0L (305 CID) | 1987 | Eng Oil Cooler Upper-Outlet Hose | 625-132 |
| V8 - 5.7L (350 CID) | 1991-87 | Eng Oil Cooler Lower-Inlet Hose | 625-131 |
| V8 - 5.7L (350 CID) | 1991-87 | Eng Oil Cooler Upper-Outlet Hose | 625-132 |
| V8 - 6.2L (379 CID) | 1991-87 | Diesel, Eng Oil Cooler Lower-Outlet Hose | 625-155 |
| V8 - 6.2L (379 CID) | 1991-87 | Diesel, Eng Oil Cooler Upper-Inlet Hose | 625-154 |
| V8 - 7.4L (454 CID) | 1990-87 | Eng Oil Cooler Lower-Inlet Hose | 625-131 |
| V8 - 7.4L (454 CID) | 1990-87 | Eng Oil Cooler Upper-Outlet Hose | 625-132 |
| FORD | | | |
| CROWN VICTORIA | | | |
| V8 - 4.6L (281 CID) | 2006-96 | Eng Oil Cooler Hose | 625-200 |
| GMC TRUCK | | | |
| C SERIES PICKUP | | | |
| V6 - 4.3L (262 CID) | 1998-96 | Eng Oil Cooler Lower-Outlet Hose | 625-183 |
| V6 - 4.3L (262 CID) | 1998-96 | Eng Oil Cooler Upper-Inlet Hose | 625-182 |
| V8 - 5.0L (305 CID) | 1999-96 | Eng Oil Cooler Lower-Inlet Hose, w/140 Amp Alternator | 625-149 |
| V8 - 5.0L (305 CID) | 1999-96 | Eng Oil Cooler Upper-Outlet Hose, w/140 Amp Alternator | 625-150 |
| V8 - 5.0L (305 CID) | 1995-94 | 3.08R, 3.42R, 3.73R, 4.10R, Eng Oil Cooler Lower-Outlet Hose | 625-140 |
| V8 - 5.0L (305 CID) | 1995-94 | 3.08R, 3.42R, 3.73R, 4.10R, Eng Oil Cooler Upper-Inlet Hose | 625-139 |
| V8 - 5.0L (305 CID) | 1993-88 | Eng Oil Cooler Lower-Outlet Hose | 625-140 |
| V8 - 5.0L (305 CID) | 1993-88 | Eng Oil Cooler Upper-Inlet Hose | 625-139 |
| V8 - 5.7L (350 CID) | 2000-96 | Eng Oil Cooler Lower-Inlet Hose | 625-149 |
| V8 - 5.7L (350 CID) | 2000-96 | Eng Oil Cooler Upper-Outlet Hose | 625-150 |
| V8 - 5.7L (350 CID) | 1995-94 | 1/2 & 3/4-Ton, 3.08R, 3.42R, 3.73R, 4.10R, 4.56R, Eng Oil Cooler Lower-Inlet Hose | 625-135 |
| V8 - 5.7L (350 CID) | 1995-94 | 1/2 & 3/4-Ton, 3.08R, 3.42R, 3.73R, 4.10R, 4.56R, Eng Oil Cooler Upper-Outlet Hose | 625-136 |
| V8 - 5.7L (350 CID) | 1995 | 1-Ton, 131.5", 155.5" Wheel Base, 3.08R, 3.42R, 3.73R, 4.10R, 4.56R, Eng Oil Cooler Lower-Inlet Hose | 625-135 |
| V8 - 5.7L (350 CID) | 1995 | 1-Ton, 131.5", 155.5" Wheel Base, 3.08R, 3.42R, 3.73R, 4.10R, 4.56R, Eng Oil Cooler Upper-Outlet Hose | 625-136 |
| V8 - 5.7L (350 CID) | 1995 | 1-Ton, 135.5", 159.5" Wheel Base, Eng Oil Cooler Lower-Inlet Hose | 625-135 |
| V8 - 5.7L (350 CID) | 1995 | 1-Ton, 135.5", 159.5" Wheel Base, Eng Oil Cooler Upper-Outlet Hose | 625-136 |
| V8 - 5.7L (350 CID) | 1993-88 | 2.73R, 3.08R, 3.42R, 3.73R, Eng Oil Cooler Lower-Outlet Hose | 625-140 |
| V8 - 5.7L (350 CID) | 1993-88 | 2.73R, 3.08R, 3.42R, 3.73R, Eng Oil Cooler Upper-Inlet Hose | 625-139 |
| V8 - 5.7L (350 CID) | 1993-88 | Exc. 2.73R, 3.08R, 3.42R, 3.73R, Eng Oil Cooler Lower-Outlet Hose | 625-161 |
| V8 - 5.7L (350 CID) | 1993-88 | Exc. 2.73R, 3.08R, 3.42R, 3.73R, Eng Oil Cooler Upper-Inlet Hose | 625-160 |
| V8 - 6.2L (379 CID) | 1993 | Diesel, Eng Oil Cooler Lower-Inlet Hose, w/HD Cooling | 625-164 |
| V8 - 6.2L (379 CID) | 1993 | Diesel, Eng Oil Cooler Lower-Outlet Hose, wo/HD Cooling | 625-157 |
| V8 - 6.2L (379 CID) | 1993 | Diesel, Eng Oil Cooler Upper-Inlet Hose, wo/HD Cooling | 625-165 |
| V8 - 6.2L (379 CID) | 1993 | Diesel, Eng Oil Cooler Upper-Outlet Hose, w/HD Cooling | 625-134 |
| V8 - 6.2L (379 CID) | 1992 | Diesel, Eng Oil Cooler Lower-Inlet Hose, w/HD Cooling, w/Hose Protector | 625-164 |
| V8 - 6.2L (379 CID) | 1992 | Diesel, Eng Oil Cooler Lower-Inlet Hose, w/HD Cooling, wo/Hose Protector | 625-133 |
| V8 - 6.2L (379 CID) | 1992 | Diesel, Eng Oil Cooler Lower-Outlet Hose, wo/HD Cooling | 625-157 |
| V8 - 6.2L (379 CID) | 1992 | Diesel, Eng Oil Cooler Upper-Inlet Hose, wo/HD Cooling | 625-165 |
| V8 - 6.2L (379 CID) | 1992 | Diesel, Eng Oil Cooler Upper-Outlet Hose, w/HD Cooling | 625-134 |
| V8 - 6.2L (379 CID) | 1991-88 | Diesel, Eng Oil Cooler Lower-Inlet Hose, w/HD Cooling | 625-133 |
| V8 - 6.2L (379 CID) | 1991-88 | Diesel, Eng Oil Cooler Lower-Outlet Hose, wo/HD Cooling | 625-157 |

Oil Cooler Line Assembly Applications

| Make/ Model/Engine | Years | Description | Dorman # |
|------------------------------------|---------|---|----------|
| GMC TRUCK (continued) | | | |
| C SERIES PICKUP (continued) | | | |
| V8 - 6.2L (379 CID) | 1991-88 | Diesel, Eng Oil Cooler Upper-Inlet Hose, wo/HD Cooling | 625-165 |
| V8 - 6.2L (379 CID) | 1991-88 | Diesel, Eng Oil Cooler Upper-Outlet Hose, w/HD Cooling | 625-134 |
| V8 - 6.2L (379 CID) | 1986-85 | Diesel, Eng Oil Cooler Lower-Outlet Hose | 625-155 |
| V8 - 6.2L (379 CID) | 1986-85 | Diesel, Eng Oil Cooler Upper-Inlet Hose | 625-154 |
| V8 - 6.5L (395 CID) | 2002-01 | Diesel, Eng Oil Cooler LH Side-Inlet Hose (Conn Nut 32mm Across Flats) | 625-113 |
| V8 - 6.5L (395 CID) | 2002-01 | Diesel, Eng Oil Cooler RH Side-Outlet Hose (Conn Nut 32mm Across Flats) | 625-112 |
| V8 - 6.5L (395 CID) | 2000-98 | Diesel, Eng Oil Cooler LH Side-Inlet Hose (Conn Nut 27mm Across Flats) | 625-147 |
| V8 - 6.5L (395 CID) | 2000-98 | Diesel, Eng Oil Cooler LH Side-Inlet Hose (Conn Nut 32mm Across Flats) | 625-113 |
| V8 - 6.5L (395 CID) | 2000-98 | Diesel, Eng Oil Cooler RH Side-Outlet Hose (Conn Nut 27mm Across Flats) | 625-148 |
| V8 - 6.5L (395 CID) | 2000-98 | Diesel, Eng Oil Cooler RH Side-Outlet Hose (Conn Nut 32mm Across Flats) | 625-112 |
| V8 - 6.5L (395 CID) | 1997 | Diesel, 1-Ton, Eng Oil Cooler LH Side-Inlet Hose (Conn Nut .875" Across Flats), Exc. 15,000 GVW | 625-143 |
| V8 - 6.5L (395 CID) | 1997 | Diesel, 1-Ton, Eng Oil Cooler LH Side-Inlet Hose (Conn Nut 25.4mm Across Flats), 15,000 GVW | 625-145 |
| V8 - 6.5L (395 CID) | 1997 | Diesel, 1-Ton, Eng Oil Cooler LH Side-Inlet Hose (Conn Nut 27mm Across Flats), Exc. 15,000 GVW | 625-147 |
| V8 - 6.5L (395 CID) | 1997 | Diesel, 1-Ton, Eng Oil Cooler LH Side-Inlet Hose (Conn Nut 32mm Across Flats) | 625-113 |
| V8 - 6.5L (395 CID) | 1997 | Diesel, 1-Ton, Eng Oil Cooler RH Side-Outlet Hose (Conn Nut 19mm Across Flats), Exc. 15,000 GVW | 625-114 |
| V8 - 6.5L (395 CID) | 1997 | Diesel, 1-Ton, Eng Oil Cooler RH Side-Outlet Hose (Conn Nut 25.4mm Across Flats), 15,000 GVW | 625-146 |
| V8 - 6.5L (395 CID) | 1997 | Diesel, 1-Ton, Eng Oil Cooler RH Side-Outlet Hose (Conn Nut 27mm Across Flats), Exc. 15,000 GVW | 625-148 |
| V8 - 6.5L (395 CID) | 1997 | Diesel, 1-Ton, Eng Oil Cooler RH Side-Outlet Hose (Conn Nut 32mm Across Flats) | 625-112 |
| V8 - 6.5L (395 CID) | 1997 | Diesel, 1/2 & 3/4-Ton, Eng Oil Cooler LH Side-Inlet Hose (Conn Nut .875" Across Flats) | 625-143 |
| V8 - 6.5L (395 CID) | 1997 | Diesel, 1/2 & 3/4-Ton, Eng Oil Cooler LH Side-Inlet Hose (Conn Nut 27mm Across Flats) | 625-147 |
| V8 - 6.5L (395 CID) | 1997 | Diesel, 1/2 & 3/4-Ton, Eng Oil Cooler RH Side-Outlet Hose (Conn Nut 19mm Across Flats) | 625-114 |
| V8 - 6.5L (395 CID) | 1997 | Diesel, 1/2 & 3/4-Ton, Eng Oil Cooler RH Side-Outlet Hose (Conn Nut 27mm Across Flats) | 625-148 |
| V8 - 6.5L (395 CID) | 1996-95 | Diesel, 1-Ton, Eng Oil Cooler LH Side-Inlet Hose (Conn Nut .875" Across Flats), Exc. 15,000 GVW | 625-143 |
| V8 - 6.5L (395 CID) | 1996-95 | Diesel, 1-Ton, Eng Oil Cooler LH Side-Inlet Hose (Conn Nut 25.4mm Across Flats), 15,000 GVW | 625-145 |
| V8 - 6.5L (395 CID) | 1996-95 | Diesel, 1-Ton, Eng Oil Cooler RH Side-Outlet Hose (Conn Nut 19mm Across Flats), Exc. 15,000 GVW | 625-114 |
| V8 - 6.5L (395 CID) | 1996-95 | Diesel, 1-Ton, Eng Oil Cooler RH Side-Outlet Hose (Conn Nut 25.4mm Across Flats), 15,000 GVW | 625-146 |
| V8 - 6.5L (395 CID) | 1996-95 | Diesel, 1/2 & 3/4-Ton, Eng Oil Cooler LH Side-Inlet Hose | 625-143 |
| V8 - 6.5L (395 CID) | 1996-95 | Diesel, 1/2 & 3/4-Ton, Eng Oil Cooler RH Side-Outlet Hose | 625-114 |
| V8 - 6.5L (395 CID) | 1994-92 | Diesel, Eng Oil Cooler Lower-Inlet Hose, Under 12,000 GVW | 625-164 |
| V8 - 6.5L (395 CID) | 1994-92 | Diesel, Eng Oil Cooler Upper-Outlet Hose, Under 12,000 GVW | 625-134 |
| V8 - 6.5L (395 CID) | 1993-92 | Diesel, Eng Oil Cooler Lower-Outlet Hose, 15,000 GVW & Over | 625-157 |
| V8 - 7.4L (454 CID) | 2000-96 | Eng Oil Cooler Lower-Inlet Hose, Under 12,000 GVW | 625-178 |
| V8 - 7.4L (454 CID) | 2000-96 | Eng Oil Cooler Upper-Outlet Hose | 625-179 |
| V8 - 7.4L (454 CID) | 1995-94 | Eng Oil Cooler Lower-Inlet Hose, wo/HD Cooling | 625-137 |
| V8 - 7.4L (454 CID) | 1995-94 | Eng Oil Cooler Upper-Outlet Hose, wo/HD Cooling | 625-111 |
| V8 - 7.4L (454 CID) | 1993 | Eng Oil Cooler Lower-Inlet Hose, wo/HD Cooling | 625-158 |
| V8 - 7.4L (454 CID) | 1993 | Eng Oil Cooler Upper-Outlet Hose, wo/HD Cooling | 625-159 |
| V8 - 7.4L (454 CID) | 1992 | Eng Oil Cooler Lower-Inlet Hose, w/Upper Radiator Shroud Broadcast Code AFB, wo/HD Cooling | 625-158 |
| V8 - 7.4L (454 CID) | 1992 | Eng Oil Cooler Upper-Outlet Hose, w/Upper Radiator Shroud Broadcast Code AFB, wo/HD Cooling | 625-159 |
| V8 - 8.1L (496 CID) | 2003-01 | Eng Oil Cooler Lower-Outlet Hose | 625-167 |
| V8 - 8.1L (496 CID) | 2003-01 | Eng Oil Cooler Upper-Inlet Hose | 625-166 |
| DENALI | | | |
| V8 - 6.0L (364 CID) | 2005 | Eng Oil Cooler Hose, 7.75MM Length Flared End Tube | 625-168 |
| V8 - 6.0L (364 CID) | 2004-01 | Eng Oil Cooler Hose | 625-168 |
| DENALI XL | | | |
| V8 - 6.0L (364 CID) | 2005 | Eng Oil Cooler Hose, 7.75MM Length Flared End Tube | 625-168 |
| V8 - 6.0L (364 CID) | 2004-01 | Eng Oil Cooler Hose | 625-168 |
| G SERIES VAN | | | |
| V6 - 4.3L (262 CID) | 1997 | Eng Oil Cooler Hose | 625-175 |
| V6 - 4.3L (262 CID) | 1996-94 | Eng Oil Cooler Lower-Inlet Hose, w/HD Cooling | 625-171 |
| V6 - 4.3L (262 CID) | 1996-94 | Eng Oil Cooler Upper-Outlet Hose, w/HD Cooling | 625-172 |
| V6 - 4.3L (262 CID) | 1993-92 | Eng Oil Cooler Lower-Inlet Hose, A/C Manual Control | 625-171 |
| V6 - 4.3L (262 CID) | 1993-92 | Eng Oil Cooler Lower-Outlet Hose, Exc. A/C Manual Control | 625-170 |
| V6 - 4.3L (262 CID) | 1993-92 | Eng Oil Cooler Upper-Inlet Hose, Exc. A/C Manual Control | 625-169 |
| V6 - 4.3L (262 CID) | 1993-92 | Eng Oil Cooler Upper-Outlet Hose, A/C Manual Control | 625-172 |
| V6 - 4.3L (262 CID) | 1991-85 | Eng Oil Cooler Lower-Outlet Hose | 625-170 |
| V6 - 4.3L (262 CID) | 1991-85 | Eng Oil Cooler Upper-Inlet Hose | 625-169 |
| V8 - 5.0L (305 CID) | 1995-92 | Eng Oil Cooler Inlet Hose | 625-153 |
| V8 - 5.0L (305 CID) | 1995-92 | Eng Oil Cooler Outlet Hose | 625-153 |
| V8 - 5.0L (305 CID) | 1991-87 | Eng Oil Cooler LH Side-Outlet Hose | 625-121 |
| V8 - 5.0L (305 CID) | 1991-87 | Eng Oil Cooler RH Side-Inlet Hose | 625-120 |
| V8 - 5.7L (350 CID) | 1996 | Eng Vin K, Eng Oil Cooler Inlet Hose | 625-153 |
| V8 - 5.7L (350 CID) | 1996 | Eng Vin K, Eng Oil Cooler Outlet Hose | 625-153 |
| V8 - 5.7L (350 CID) | 1996 | Eng Vin R, Eng Oil Cooler Lower-Outlet Hose | 625-152 |
| V8 - 5.7L (350 CID) | 1996 | Eng Vin R, Eng Oil Cooler Upper-Inlet Hose | 625-151 |
| V8 - 5.7L (350 CID) | 1995-92 | Eng Oil Cooler Inlet Hose | 625-153 |
| V8 - 5.7L (350 CID) | 1995-92 | Eng Oil Cooler Outlet Hose | 625-153 |
| V8 - 5.7L (350 CID) | 1991-87 | Eng Oil Cooler LH Side-Outlet Hose | 625-121 |
| V8 - 5.7L (350 CID) | 1991-87 | Eng Oil Cooler RH Side-Inlet Hose | 625-120 |

Oil Cooler Line Assembly Applications

| Make/ Model/Engine | Years | Description | Dorman # |
|---------------------------------|---------|---|----------|
| GMC TRUCK (continued) | | | |
| G SERIES VAN (continued) | | | |
| V8 - 5.7L (350 CID) | 1986-85 | Eng Vin M, Eng Oil Cooler LH Side-Outlet Hose | 625-121 |
| V8 - 5.7L (350 CID) | 1986-85 | Eng Vin M, Eng Oil Cooler RH Side-Inlet Hose | 625-120 |
| V8 - 6.2L (379 CID) | 1993-92 | Diesel, Eng Oil Cooler Lower-Inlet Hose | 625-173 |
| V8 - 6.2L (379 CID) | 1993-92 | Diesel, Eng Oil Cooler Upper-Outlet Hose | 625-174 |
| V8 - 6.2L (379 CID) | 1991-85 | Diesel, Eng Oil Cooler Lower-Outlet Hose | 625-126 |
| V8 - 6.2L (379 CID) | 1991-85 | Diesel, Eng Oil Cooler Upper-Inlet Hose | 625-125 |
| V8 - 6.5L (395 CID) | 1996-94 | Diesel, Eng Oil Cooler Lower-Inlet Pipe | 625-110 |
| V8 - 6.5L (395 CID) | 1996-94 | Diesel, Eng Oil Cooler Upper-Outlet Pipe | 625-109 |
| V8 - 6.5L (395 CID) | 1996 | Diesel, Auxiliary Eng Oil Cooler Lower-Outlet Hose | 625-130 |
| V8 - 6.5L (395 CID) | 1996 | Diesel, Auxiliary Eng Oil Cooler Upper-Inlet Hose | 625-106 |
| V8 - 6.5L (395 CID) | 1996 | Diesel, Eng Oil Cooler Lower-Inlet Hose | 625-129 |
| JIMMY | | | |
| V8 - 5.0L (305 CID) | 1987-85 | 4WD, Eng Oil Cooler Lower-Inlet Hose | 625-131 |
| V8 - 5.0L (305 CID) | 1987-85 | 4WD, Eng Oil Cooler Upper-Outlet Hose | 625-132 |
| V8 - 5.7L (350 CID) | 1991-85 | 4WD, Eng Oil Cooler Lower-Inlet Hose | 625-131 |
| V8 - 5.7L (350 CID) | 1991-85 | 4WD, Eng Oil Cooler Upper-Outlet Hose | 625-132 |
| V8 - 6.2L (379 CID) | 1991-85 | Diesel, Eng Oil Cooler Upper-Inlet Hose | 625-154 |
| K SERIES PICKUP | | | |
| V6 - 4.3L (262 CID) | 1998-96 | Eng Oil Cooler Lower-Outlet Hose | 625-183 |
| V6 - 4.3L (262 CID) | 1998-96 | Eng Oil Cooler Upper-Inlet Hose | 625-182 |
| V8 - 5.0L (305 CID) | 1999-96 | Eng Oil Cooler Lower-Outlet Hose, w/140 Amp Alternator | 625-123 |
| V8 - 5.0L (305 CID) | 1999-96 | Eng Oil Cooler Upper-Inlet Hose, w/140 Amp Alternator | 625-101 |
| V8 - 5.0L (305 CID) | 1995-94 | 3.42R, 3.73R, Eng Oil Cooler Lower-Outlet Hose | 625-142 |
| V8 - 5.0L (305 CID) | 1995-94 | 3.42R, 3.73R, Eng Oil Cooler Upper-Inlet Hose | 625-141 |
| V8 - 5.0L (305 CID) | 1993-88 | Eng Oil Cooler Lower-Outlet Hose | 625-142 |
| V8 - 5.0L (305 CID) | 1993-88 | Eng Oil Cooler Upper-Inlet Hose | 625-141 |
| V8 - 5.0L (305 CID) | 1986-85 | Eng Oil Cooler Lower-Inlet Hose | 625-131 |
| V8 - 5.0L (305 CID) | 1986-85 | Eng Oil Cooler Upper-Outlet Hose | 625-132 |
| V8 - 5.7L (350 CID) | 2000-96 | Eng Oil Cooler Lower-Outlet Hose | 625-123 |
| V8 - 5.7L (350 CID) | 2000-96 | Eng Oil Cooler Upper-Inlet Hose | 625-101 |
| V8 - 5.7L (350 CID) | 1995-94 | 1-Ton, 131.5", 155.5" Wheel Base, 3.73R, 4.10R, 4.56R, Eng Oil Cooler Lower-Outlet Hose | 625-107 |
| V8 - 5.7L (350 CID) | 1995-94 | 1-Ton, 131.5", 155.5" Wheel Base, 3.73R, 4.10R, 4.56R, Eng Oil Cooler Upper-Inlet Hose | 625-108 |
| V8 - 5.7L (350 CID) | 1995-94 | 1-Ton, 135.5", 159.5" Wheel Base, Eng Oil Cooler Lower-Outlet Hose | 625-107 |
| V8 - 5.7L (350 CID) | 1995-94 | 1-Ton, 135.5", 159.5" Wheel Base, Eng Oil Cooler Upper-Inlet Hose | 625-108 |
| V8 - 5.7L (350 CID) | 1995-94 | 1/2 & 3/4-Ton, 3.42R, 3.73R, 4.10R, 4.56R, Eng Oil Cooler Lower-Outlet Hose | 625-107 |
| V8 - 5.7L (350 CID) | 1995-94 | 1/2 & 3/4-Ton, 3.42R, 3.73R, 4.10R, 4.56R, Eng Oil Cooler Upper-Inlet Hose | 625-108 |
| V8 - 5.7L (350 CID) | 1993-91 | 4.10R, 4.56R, Eng Oil Cooler Lower-Outlet Hose | 625-163 |
| V8 - 5.7L (350 CID) | 1993-91 | 4.10R, 4.56R, Eng Oil Cooler Upper-Inlet Hose | 625-162 |
| V8 - 5.7L (350 CID) | 1993-88 | 3.42R, 3.73R, Eng Oil Cooler Lower-Outlet Hose | 625-142 |
| V8 - 5.7L (350 CID) | 1993-88 | 3.42R, 3.73R, Eng Oil Cooler Upper-Inlet Hose | 625-141 |
| V8 - 5.7L (350 CID) | 1986-85 | Eng Oil Cooler Lower-Inlet Hose | 625-131 |
| V8 - 5.7L (350 CID) | 1986-85 | Eng Oil Cooler Upper-Outlet Hose | 625-132 |
| V8 - 6.2L (379 CID) | 1993 | Diesel, Eng Oil Cooler Lower-Inlet Hose, w/HD Cooling | 625-164 |
| V8 - 6.2L (379 CID) | 1993 | Diesel, Eng Oil Cooler Lower-Outlet Hose, wo/HD Cooling | 625-157 |
| V8 - 6.2L (379 CID) | 1993 | Diesel, Eng Oil Cooler Upper-Inlet Hose, wo/HD Cooling | 625-165 |
| V8 - 6.2L (379 CID) | 1993 | Diesel, Eng Oil Cooler Upper-Outlet Hose, w/HD Cooling | 625-134 |
| V8 - 6.2L (379 CID) | 1992 | Diesel, Eng Oil Cooler Lower-Inlet Hose, w/HD Cooling, w/Hose Protector | 625-164 |
| V8 - 6.2L (379 CID) | 1992 | Diesel, Eng Oil Cooler Lower-Outlet Hose, w/HD Cooling, wo/Hose Protector | 625-133 |
| V8 - 6.2L (379 CID) | 1992 | Diesel, Eng Oil Cooler Lower-Outlet Hose, wo/HD Cooling | 625-157 |
| V8 - 6.2L (379 CID) | 1992 | Diesel, Eng Oil Cooler Upper-Inlet Hose, wo/HD Cooling | 625-165 |
| V8 - 6.2L (379 CID) | 1992 | Diesel, Eng Oil Cooler Upper-Outlet Hose, w/HD Cooling | 625-134 |
| V8 - 6.2L (379 CID) | 1991-88 | Diesel, Eng Oil Cooler Lower-Inlet Hose, w/HD Cooling | 625-133 |
| V8 - 6.2L (379 CID) | 1991-88 | Diesel, Eng Oil Cooler Lower-Outlet Hose, wo/HD Cooling | 625-157 |
| V8 - 6.2L (379 CID) | 1991-88 | Diesel, Eng Oil Cooler Upper-Inlet Hose, wo/HD Cooling | 625-165 |
| V8 - 6.2L (379 CID) | 1991-88 | Diesel, Eng Oil Cooler Upper-Outlet Hose, w/HD Cooling | 625-134 |
| V8 - 6.2L (379 CID) | 1986-85 | Diesel, Eng Oil Cooler Lower-Outlet Hose | 625-155 |
| V8 - 6.2L (379 CID) | 1986-85 | Diesel, Eng Oil Cooler Upper-Inlet Hose | 625-154 |
| V8 - 6.5L (395 CID) | 2000-98 | Diesel, Eng Oil Cooler LH Side-Inlet Hose (Conn Nut 27mm Across Flats) | 625-147 |
| V8 - 6.5L (395 CID) | 2000-98 | Diesel, Eng Oil Cooler RH Side-Outlet Hose (Conn Nut 27mm Across Flats) | 625-148 |
| V8 - 6.5L (395 CID) | 1997 | Diesel, Eng Oil Cooler LH Side-Inlet Hose (Conn Nut .875" Across Flats) | 625-143 |
| V8 - 6.5L (395 CID) | 1997 | Diesel, Eng Oil Cooler LH Side-Inlet Hose (Conn Nut 27mm Across Flats) | 625-147 |
| V8 - 6.5L (395 CID) | 1997 | Diesel, Eng Oil Cooler RH Side-Outlet Hose (Conn Nut 19mm Across Flats) | 625-114 |
| V8 - 6.5L (395 CID) | 1997 | Diesel, Eng Oil Cooler RH Side-Outlet Hose (Conn Nut 27mm Across Flats) | 625-148 |
| V8 - 6.5L (395 CID) | 1996-95 | Diesel, Eng Oil Cooler LH Side-Inlet Hose (Conn Nut .875" Across Flats) | 625-143 |
| V8 - 6.5L (395 CID) | 1996-95 | Diesel, Eng Oil Cooler RH Side-Outlet Hose (Conn Nut 19mm Across Flats) | 625-114 |
| V8 - 6.5L (395 CID) | 1994-92 | Diesel, Eng Oil Cooler Lower-Inlet Hose, Under 12,000 GVW | 625-164 |
| V8 - 6.5L (395 CID) | 1994-92 | Diesel, Eng Oil Cooler Upper-Outlet Hose, Under 12,000 GVW | 625-134 |
| V8 - 7.4L (454 CID) | 2000-96 | Eng Oil Cooler Lower-Inlet Hose, Under 12,000 GVW | 625-178 |
| V8 - 7.4L (454 CID) | 2000-96 | Eng Oil Cooler Upper-Outlet Hose | 625-179 |
| V8 - 7.4L (454 CID) | 1995-94 | Eng Oil Cooler Lower-Inlet Hose, wo/HD Cooling | 625-137 |
| V8 - 7.4L (454 CID) | 1995-94 | Eng Oil Cooler Upper-Outlet Hose, wo/HD Cooling | 625-111 |
| V8 - 7.4L (454 CID) | 1986-85 | Eng Oil Cooler Lower-Inlet Hose | 625-131 |
| V8 - 7.4L (454 CID) | 1986-85 | Eng Oil Cooler Upper-Outlet Hose | 625-132 |
| R SERIES PICKUP | | | |
| V8 - 6.2L (379 CID) | 1991-87 | Diesel, Eng Oil Cooler Lower-Outlet Hose | 625-155 |
| V8 - 6.2L (379 CID) | 1991-87 | Diesel, Eng Oil Cooler Upper-Inlet Hose | 625-154 |
| S15 JIMMY | | | |
| V6 - 4.3L (262 CID) | 2001-96 | 2WD, Eng Oil Cooler Hose | 625-122 |
| V6 - 4.3L (262 CID) | 2001-96 | 4WD, Eng Oil Cooler Pipe | 625-100 |
| V6 - 4.3L (262 CID) | 2001-96 | 4WD, Eng Oil Filter Hose | 625-001 |
| V6 - 4.3L (262 CID) | 1995 | 2WD, Eng Oil Cooler Lower-Outlet Hose | 625-128 |

Oil Cooler Line Assembly Applications

| Make/ Model/Engine | Years | Description | Dorman # |
|------------------------------|---------|---|----------|
| GMC TRUCK (continued) | | | |
| S15 JIMMY (continued) | | | |
| V6 - 4.3L (262 CID) | 1995 | 2WD, Eng Oil Cooler Upper-Inlet Hose | 625-127 |
| V6 - 4.3L (262 CID) | 1995 | 4WD, Eng Oil Cooler Hose | 625-104 |
| V6 - 4.3L (262 CID) | 1995 | 4WD, Eng Oil Filter Hose | 625-103 |
| V6 - 4.3L (262 CID) | 1994-92 | 4WD, Eng VIN Z, Eng Oil Cooler Hose, w/HD Cooling | 625-176 |
| V6 - 4.3L (262 CID) | 1994-88 | 4WD, Eng Oil Filter Hose | 625-102 |
| V6 - 4.3L (262 CID) | 1991-88 | 4WD, Eng VIN Z, Eng Oil Cooler Hose | 625-176 |
| S15 PICKUP | | | |
| V6 - 4.3L (262 CID) | 1990-88 | 4WD, Eng Oil Filter Hose | 625-102 |
| S15 SONOMA | | | |
| V6 - 4.3L (262 CID) | 2004-96 | 2WD, Eng Oil Cooler Hose | 625-122 |
| V6 - 4.3L (262 CID) | 2004-96 | 4WD, Eng Oil Cooler Pipe | 625-100 |
| V6 - 4.3L (262 CID) | 2004-96 | 4WD, Eng Oil Filter Hose | 625-001 |
| V6 - 4.3L (262 CID) | 1995-94 | 2WD, Eng Oil Cooler Lower-Outlet Hose | 625-128 |
| V6 - 4.3L (262 CID) | 1995-94 | 2WD, Eng Oil Cooler Upper-Inlet Hose | 625-127 |
| V6 - 4.3L (262 CID) | 1995-94 | 4WD, Eng Oil Cooler Hose | 625-104 |
| V6 - 4.3L (262 CID) | 1995-94 | 4WD, Eng Oil Filter Hose | 625-103 |
| V6 - 4.3L (262 CID) | 1993-91 | 4WD, Eng Oil Filter Hose | 625-102 |
| S15 SYCLONE | | | |
| V6 - 4.3L (262 CID) | 1991 | 4WD, Eng Oil Cooler Hose | 625-176 |
| V6 - 4.3L (262 CID) | 1991 | 4WD, Eng Oil Filter Hose | 625-102 |
| S15 TYPHOON | | | |
| V6 - 4.3L (262 CID) | 1993-92 | 4WD, Eng Oil Cooler Hose | 625-176 |
| V6 - 4.3L (262 CID) | 1993-92 | 4WD, Eng Oil Filter Hose | 625-102 |
| SAFARI VAN | | | |
| V6 - 4.3L (262 CID) | 2005-96 | Eng Oil Cooler Hose | 625-105 |
| V6 - 4.3L (262 CID) | 1995 | Eng Oil Cooler Lower-Outlet Hose | 625-144 |
| V6 - 4.3L (262 CID) | 1995 | Eng Oil Cooler Upper-Inlet Hose | 625-138 |
| V6 - 4.3L (262 CID) | 1994 | 2WD, Eng Oil Cooler Lower-Outlet Hose | 625-181 |
| V6 - 4.3L (262 CID) | 1994 | 2WD, Eng Oil Cooler Upper-Inlet Hose | 625-180 |
| V6 - 4.3L (262 CID) | 1993-85 | 2WD, Eng Oil Cooler Lower-Outlet Hose | 625-119 |
| V6 - 4.3L (262 CID) | 1993-85 | 2WD, Eng Oil Cooler Upper-Inlet Hose | 625-118 |
| SAVANA VAN | | | |
| V6 - 4.3L (262 CID) | 2002-96 | Eng Oil Cooler Hose | 625-175 |
| V8 - 5.7L (350 CID) | 2002-96 | Eng Oil Cooler Lower-Outlet Hose | 625-152 |
| V8 - 5.7L (350 CID) | 2002-96 | Eng Oil Cooler Upper-Inlet Hose | 625-151 |
| V8 - 6.0L (364 CID) | 2004-03 | Eng Oil Cooler Hose | 625-168 |
| V8 - 6.5L (395 CID) | 2002-96 | Diesel, Auxiliary Eng Oil Cooler Lower-Outlet Hose | 625-130 |
| V8 - 6.5L (395 CID) | 2002-96 | Diesel, Auxiliary Eng Oil Cooler Upper-Inlet Hose | 625-106 |
| V8 - 6.5L (395 CID) | 2002-96 | Diesel, Eng Oil Cooler Lower-Inlet Hose | 625-129 |
| SIERRA | | | |
| V8 - 5.3L (323 CID) | 2005 | Eng Oil Cooler Hose, VIN Z, Flex Fuel, 7.75MM Length Flared End Tube | 625-168 |
| V8 - 6.0L (364 CID) | 2005 | Eng Oil Cooler Hose, 7.75MM Length Flared End Tube | 625-168 |
| V8 - 6.0L (364 CID) | 2004-99 | Eng Oil Cooler Hose | 625-168 |
| SUBURBAN | | | |
| V8 - 5.0L (305 CID) | 1986-85 | 4WD, Eng Oil Cooler Lower-Inlet Hose | 625-131 |
| V8 - 5.0L (305 CID) | 1986-85 | 4WD, Eng Oil Cooler Upper-Outlet Hose | 625-132 |
| V8 - 5.7L (350 CID) | 1999-96 | 2WD, Eng Oil Cooler Lower-Inlet Hose | 625-149 |
| V8 - 5.7L (350 CID) | 1999-96 | 2WD, Eng Oil Cooler Upper-Outlet Hose | 625-150 |
| V8 - 5.7L (350 CID) | 1999-96 | 4WD, Eng Oil Cooler Lower-Outlet Hose | 625-123 |
| V8 - 5.7L (350 CID) | 1999-96 | 4WD, Eng Oil Cooler Upper-Inlet Hose | 625-101 |
| V8 - 5.7L (350 CID) | 1995-94 | 2WD, 3.08R, 3.42R, 3.73R, 4.10R, 4.56R, Eng Oil Cooler Lower-Inlet Hose | 625-135 |
| V8 - 5.7L (350 CID) | 1995-94 | 2WD, 3.08R, 3.42R, 3.73R, 4.10R, 4.56R, Eng Oil Cooler Upper-Outlet Hose | 625-136 |
| V8 - 5.7L (350 CID) | 1995-94 | 4WD, 3.42R, 3.73R, 4.10R, 4.56R, Eng Oil Cooler Lower-Outlet Hose | 625-107 |
| V8 - 5.7L (350 CID) | 1995-94 | 4WD, 3.42R, 3.73R, 4.10R, 4.56R, Eng Oil Cooler Upper-Inlet Hose | 625-108 |
| V8 - 5.7L (350 CID) | 1993-92 | 2WD, 3.08R, 3.42R, 3.73R, Eng Oil Cooler Lower-Outlet Hose | 625-140 |
| V8 - 5.7L (350 CID) | 1993-92 | 2WD, 3.08R, 3.42R, 3.73R, Eng Oil Cooler Upper-Inlet Hose | 625-139 |
| V8 - 5.7L (350 CID) | 1993-92 | 2WD, Exc. 3.08R, 3.42R, 3.73R, Eng Oil Cooler Lower-Outlet Hose | 625-161 |
| V8 - 5.7L (350 CID) | 1993-92 | 2WD, Exc. 3.08R, 3.42R, 3.73R, Eng Oil Cooler Upper-Inlet Hose | 625-160 |
| V8 - 5.7L (350 CID) | 1993-92 | 4WD, 3.42R, 3.73R, Eng Oil Cooler Lower-Outlet Hose | 625-142 |
| V8 - 5.7L (350 CID) | 1993-92 | 4WD, 3.42R, 3.73R, Eng Oil Cooler Upper-Inlet Hose | 625-141 |
| V8 - 5.7L (350 CID) | 1993-92 | 4WD, 4.10R, 4.56R, Eng Oil Cooler Lower-Outlet Hose | 625-163 |
| V8 - 5.7L (350 CID) | 1993-92 | 4WD, 4.10R, 4.56R, Eng Oil Cooler Upper-Inlet Hose | 625-162 |
| V8 - 5.7L (350 CID) | 1991-85 | 4WD, Eng Oil Cooler Lower-Inlet Hose | 625-131 |
| V8 - 5.7L (350 CID) | 1991-85 | 4WD, Eng Oil Cooler Upper-Outlet Hose | 625-132 |
| V8 - 6.2L (379 CID) | 1993-92 | Diesel, Eng Oil Cooler Upper-Outlet Hose, Auxiliary Cooler | 625-134 |
| V8 - 6.2L (379 CID) | 1993 | Diesel, Eng Oil Cooler Lower-Inlet Hose, w/HD Cooling | 625-164 |
| V8 - 6.2L (379 CID) | 1993 | Diesel, Eng Oil Cooler Lower-Outlet Hose, wo/HD Cooling | 625-157 |
| V8 - 6.2L (379 CID) | 1993 | Diesel, Eng Oil Cooler Upper-Inlet Hose, wo/HD Cooling | 625-165 |
| V8 - 6.2L (379 CID) | 1993 | Diesel, Eng Oil Cooler Upper-Outlet Hose, w/HD Cooling | 625-134 |
| V8 - 6.2L (379 CID) | 1992 | Diesel, Eng Oil Cooler Lower-Inlet Hose, w/HD Cooling, w/Hose Protector | 625-164 |
| V8 - 6.2L (379 CID) | 1992 | Diesel, Eng Oil Cooler Lower-Outlet Hose, w/HD Cooling, wo/Hose Protector | 625-133 |
| V8 - 6.2L (379 CID) | 1992 | Diesel, Eng Oil Cooler Lower-Outlet Hose, wo/HD Cooling | 625-157 |
| V8 - 6.2L (379 CID) | 1992 | Diesel, Eng Oil Cooler Upper-Inlet Hose, wo/HD Cooling | 625-165 |
| V8 - 6.2L (379 CID) | 1992 | Diesel, Eng Oil Cooler Upper-Outlet Hose, w/HD Cooling | 625-134 |
| V8 - 6.2L (379 CID) | 1991-87 | Diesel, Eng Oil Cooler Lower-Outlet Hose | 625-155 |
| V8 - 6.2L (379 CID) | 1991-87 | Diesel, Eng Oil Cooler Upper-Inlet Hose | 625-154 |
| V8 - 6.2L (379 CID) | 1986-85 | Diesel, Eng Oil Cooler Lower-Outlet Hose | 625-155 |
| V8 - 6.2L (379 CID) | 1986-85 | Diesel, Eng Oil Cooler Upper-Inlet Hose | 625-154 |
| V8 - 6.5L (395 CID) | 1999-98 | Diesel, Eng Oil Cooler LH Side-Inlet Hose (Conn Nut 27mm Across Flats) | 625-147 |
| V8 - 6.5L (395 CID) | 1999-98 | Diesel, Eng Oil Cooler RH Side-Inlet Hose (Conn Nut 27mm Across Flats) | 625-148 |
| V8 - 6.5L (395 CID) | 1997 | Diesel, Eng Oil Cooler LH Side-Inlet Hose (Conn Nut .875" Across Flats) | 625-143 |

Oil Cooler Line Assembly Applications

| Make/ Model/Engine | Years | Description | Dorman # |
|------------------------------|---------|--|----------|
| GMC TRUCK (continued) | | | |
| SUBURBAN (continued) | | | |
| V8 - 6.5L (395 CID) | 1997 | Diesel, Eng Oil Cooler LH Side-Inlet Hose (Conn Nut 27mm Across Flats) | 625-147 |
| V8 - 6.5L (395 CID) | 1997 | Diesel, Eng Oil Cooler RH Side-Outlet Hose (Conn Nut 19mm Across Flats) | 625-114 |
| V8 - 6.5L (395 CID) | 1997 | Diesel, Eng Oil Cooler RH Side-Outlet Hose (Conn Nut 27mm Across Flats) | 625-148 |
| V8 - 6.5L (395 CID) | 1996-95 | Diesel, Eng Oil Cooler LH Side-Inlet Hose | 625-143 |
| V8 - 6.5L (395 CID) | 1996-95 | Diesel, Eng Oil Cooler RH Side-Outlet Hose | 625-114 |
| V8 - 6.5L (395 CID) | 1994-92 | Diesel, Eng Oil Cooler Lower-Inlet Hose, Under 12,000 GVW | 625-164 |
| V8 - 6.5L (395 CID) | 1994-92 | Diesel, Eng Oil Cooler Upper-Outlet Hose, Under 12,000 GVW | 625-134 |
| V8 - 6.5L (395 CID) | 1993-92 | Diesel, Eng Oil Cooler Upper-Outlet Hose | 625-134 |
| V8 - 7.4L (454 CID) | 1999-96 | Eng Oil Cooler Lower-Inlet Hose, Under 12,000 GVW | 625-178 |
| V8 - 7.4L (454 CID) | 1999-96 | Eng Oil Cooler Upper-Outlet Hose | 625-179 |
| V8 - 7.4L (454 CID) | 1995-94 | Eng Oil Cooler Lower-Inlet Hose, wo/HD Cooling | 625-137 |
| V8 - 7.4L (454 CID) | 1995-94 | Eng Oil Cooler Upper-Outlet Hose, wo/HD Cooling | 625-111 |
| V8 - 7.4L (454 CID) | 1993 | Eng Oil Cooler Lower-Inlet Hose, wo/HD Cooling | 625-158 |
| V8 - 7.4L (454 CID) | 1993 | Eng Oil Cooler Upper-Outlet Hose, wo/HD Cooling | 625-159 |
| V8 - 7.4L (454 CID) | 1992 | Eng Oil Cooler Lower-Inlet Hose, w/Upper Radiator Shroud Broadcast Code AFB, wo/HD Cooling | 625-158 |
| V8 - 7.4L (454 CID) | 1992 | Eng Oil Cooler Upper-Outlet Hose, w/Upper Radiator Shroud Broadcast Code AFB, wo/HD Cooling | 625-159 |
| V8 - 7.4L (454 CID) | 1990-85 | 4WD, Eng Oil Cooler Lower-Inlet Hose | 625-131 |
| V8 - 7.4L (454 CID) | 1990-85 | 4WD, Eng Oil Cooler Upper-Outlet Hose | 625-132 |
| V SERIES PICKUP | | | |
| V8 - 5.0L (305 CID) | 1987 | Eng Oil Cooler Lower-Inlet Hose | 625-131 |
| V8 - 5.0L (305 CID) | 1987 | Eng Oil Cooler Upper-Outlet Hose | 625-132 |
| V8 - 5.7L (350 CID) | 1991-87 | Eng Oil Cooler Lower-Inlet Hose | 625-131 |
| V8 - 5.7L (350 CID) | 1991-87 | Eng Oil Cooler Upper-Outlet Hose | 625-132 |
| V8 - 6.2L (379 CID) | 1991-87 | Diesel, Eng Oil Cooler Lower-Outlet Hose | 625-155 |
| V8 - 6.2L (379 CID) | 1991-87 | Diesel, Eng Oil Cooler Upper-Inlet Hose | 625-154 |
| V8 - 7.4L (454 CID) | 1990-87 | Eng Oil Cooler Lower-Inlet Hose | 625-131 |
| V8 - 7.4L (454 CID) | 1990-87 | Eng Oil Cooler Upper-Outlet Hose | 625-132 |
| YUKON | | | |
| V8 - 5.3L (323 CID) | 2005 | Eng Oil Cooler Hose, VIN Z, Flex Fuel, 7.75MM Length Flared End Tube | 625-168 |
| V8 - 5.7L (350 CID) | 2000-96 | 2WD, Eng Oil Cooler Lower-Inlet Hose | 625-149 |
| V8 - 5.7L (350 CID) | 2000-96 | 2WD, Eng Oil Cooler Upper-Outlet Hose | 625-150 |
| V8 - 5.7L (350 CID) | 2000-96 | 4WD, Eng Oil Cooler Lower-Outlet Hose | 625-123 |
| V8 - 5.7L (350 CID) | 2000-96 | 4WD, Eng Oil Cooler Upper-Inlet Hose | 625-101 |
| V8 - 5.7L (350 CID) | 1995-94 | 2WD, 3.08R, 3.42R, 3.73R, 4.10R, 4.56R, Eng Oil Cooler Lower-Inlet Hose | 625-135 |
| V8 - 5.7L (350 CID) | 1995-94 | 2WD, 3.08R, 3.42R, 3.73R, 4.10R, 4.56R, Eng Oil Cooler Upper-Outlet Hose | 625-136 |
| V8 - 5.7L (350 CID) | 1995-94 | 4WD, 3.42R, 3.73R, 4.10R, 4.56R, Eng Oil Cooler Lower-Outlet Hose | 625-107 |
| V8 - 5.7L (350 CID) | 1995-94 | 4WD, 3.42R, 3.73R, 4.10R, 4.56R, Eng Oil Cooler Upper-Inlet Hose | 625-108 |
| V8 - 5.7L (350 CID) | 1993-92 | 2WD, 3.08R, 3.42R, 3.73R, Eng Oil Cooler Lower-Outlet Hose | 625-140 |
| V8 - 5.7L (350 CID) | 1993-92 | 2WD, 3.08R, 3.42R, 3.73R, Eng Oil Cooler Upper-Inlet Hose | 625-139 |
| V8 - 5.7L (350 CID) | 1993-92 | 2WD, Exc. 3.08R, 3.42R, 3.73R, Eng Oil Cooler Lower-Outlet Hose | 625-161 |
| V8 - 5.7L (350 CID) | 1993-92 | 2WD, Exc. 3.08R, 3.42R, 3.73R, Eng Oil Cooler Upper-Inlet Hose | 625-160 |
| V8 - 5.7L (350 CID) | 1993-92 | 4WD, 3.42R, 3.73R, Eng Oil Cooler Lower-Outlet Hose | 625-142 |
| V8 - 5.7L (350 CID) | 1993-92 | 4WD, 3.42R, 3.73R, Eng Oil Cooler Upper-Inlet Hose | 625-141 |
| V8 - 5.7L (350 CID) | 1993-92 | 4WD, 4.10R, 4.56, Eng Oil Cooler Lower-Outlet Hose | 625-163 |
| V8 - 5.7L (350 CID) | 1993-92 | 4WD, 4.10R, 4.56R, Eng Oil Cooler Upper-Inlet Hose | 625-162 |
| V8 - 6.0L (364 CID) | 2005 | Eng Oil Cooler Hose, 7.75MM Length Flared End Tube | 625-168 |
| V8 - 6.0L (364 CID) | 2004-00 | Eng Oil Cooler Hose | 625-168 |
| V8 - 6.5L (395 CID) | 1999-98 | Diesel, Eng Oil Cooler LH Side-Inlet Hose (Conn Nut 27mm Across Flats) | 625-147 |
| V8 - 6.5L (395 CID) | 1999-98 | Diesel, Eng Oil Cooler RH Side-Outlet Hose (Conn Nut 27mm Across Flats) | 625-148 |
| V8 - 6.5L (395 CID) | 1997 | Diesel, Eng Oil Cooler LH Side-Inlet Hose (Conn Nut .875" Across Flats) | 625-143 |
| V8 - 6.5L (395 CID) | 1997 | Diesel, Eng Oil Cooler LH Side-Inlet Hose (Conn Nut 27mm Across Flats) | 625-147 |
| V8 - 6.5L (395 CID) | 1997 | Diesel, Eng Oil Cooler RH Side-Outlet Hose (Conn Nut 19mm Across Flats) | 625-114 |
| V8 - 6.5L (395 CID) | 1997 | Diesel, Eng Oil Cooler RH Side-Outlet Hose (Conn Nut 27mm Across Flats) | 625-148 |
| V8 - 6.5L (395 CID) | 1996-95 | Diesel, Eng Oil Cooler LH Side-Inlet Hose | 625-143 |
| V8 - 6.5L (395 CID) | 1996-95 | Diesel, Eng Oil Cooler RH Side-Outlet Hose | 625-114 |
| V8 - 6.5L (395 CID) | 1994 | Diesel, Eng Oil Cooler Lower-Inlet Hose | 625-164 |
| V8 - 6.5L (395 CID) | 1994 | Diesel, Eng Oil Cooler Upper-Outlet Hose | 625-134 |
| YUKON XL | | | |
| V8 - 6.0L (364 CID) | 2005 | Eng Oil Cooler Hose, 7.75MM Length Flared End Tube | 625-168 |
| V8 - 6.0L (364 CID) | 2004-01 | Eng Oil Cooler Hose | 625-168 |
| LINCOLN | | | |
| TOWN CAR | | | |
| V8 - 4.6L (281 CID) | 2006-96 | Eng Oil Cooler Hose | 625-200 |
| MERCURY | | | |
| GRAND MARQUIS | | | |
| V8 - 4.6L (281 CID) | 2006-96 | Eng Oil Cooler Hose | 625-200 |
| OLDSMOBILE | | | |
| BRAVADA | | | |
| V6 - 4.3L (262 CID) | 2001-96 | 4WD, Eng Oil Cooler Pipe | 625-100 |
| V6 - 4.3L (262 CID) | 2001-96 | 4WD, Eng Oil Filter Hose | 625-001 |
| V6 - 4.3L (262 CID) | 1994-92 | 4WD, Eng Vin Z, Eng Oil Cooler Hose, w/HD Cooling | 625-176 |
| V6 - 4.3L (262 CID) | 1994-91 | 4WD, Eng Oil Filter Hose | 625-102 |
| V6 - 4.3L (262 CID) | 1991 | 4WD, Eng Vin Z, Eng Oil Cooler Hose | 625-176 |

TECH TRAYS



Have the Part You Need, When You Need It
STOP WASTING BAY TIME!

Part # 030-541 OIL DRAIN PLUG GASKETS TECH TRAY
• 20 SKUs, 115 pieces • Tray measures 13-1/8" W x 2-5/16" H x 9" D

| | | | | |
|-------------------------------------|------------------------------------|------------------------------------|---|--------------------------------------|
| 095-001 Copper 1/2" (M12) | 095-014 Metal Crush 1/2" | 097-003 Nylon 1 1/16" | 097-016 Fiber M12 | 097-022 Nylon 1/2" (M12) |
| 095-002 Copper 5/8" (M16) | 095-015 Aluminum 14.5mm | 097-004 Nylon 3/4" (M16) | 097-018 Fiber M16 | 097-025 Rubber/Metal 9/16" |
| 095-004 Copper 3/4" | 097-001 Nylon 1/2" (M12) | 097-005 Nylon 7/8" (M20) | 097-019 Fiber M20 | 097-026 Fiber 9/16" |
| 095-010 Copper 9/16" | 097-002 Nylon 5/8" | 097-010 Nylon 9/16" | 097-021 Rubber/Metal 1/2" (M12) | 097-027 Fiber 1/2" |

030-541
Oil Drain
Plug Gaskets



Part # 030-539 OIL DRAIN PLUGS WITH GASKETS TECH TRAY
• 22 SKUs, 44 pieces • Tray measures 13-1/8" W x 2-5/16" H x 9" D

| | | | | | |
|--|--|--|---|--|--|
| 090-005 1/2"-20 Standard | 090-034 M12-1.75 Pilot Point | 090-042 M18-1.5 Standard | 090-055 M20-1.5 Standard | 090-075 M14-1.5 Standard | 090-088 M12-1.5 Standard |
| 090-015 1/2"-20 Single Oversized | 090-038 M12-1.25 Standard | 090-049 M12-1.25 Pilot Point | 090-058 1/2"-20 Pilot Point w/ Molded Gasket | 090-076 M14-1.25 Pilot Point | 090-098 M14-1.5 Pilot Point w/ Molded Gasket |
| 090-031 1/2"-20 Double Oversized | 090-039 M16-1.33 Standard | 090-052 1/2"-20 Pilot Point | 090-059 M12-1.75 Pilot Point w/ Molded Gasket | 090-079 M12-1.75 Pilot Point w/ Inset Gasket | |
| 090-033 M14-1.5 Standard | 090-040 M20-1.5 Standard | 090-053 M14-1.5 Pilot Point | 090-060 M12-1.75 Pilot Point w/ Inset Gasket | 090-084 M18-1.5 Pilot Point | |

030-539
Oil Drain Plugs
with Gaskets



**Check Our Website for
Details on Tech Tray Components
visit www.DormanProducts.com**